



OM-4407

203 236U

May 2004

Processes



MIG (GMAW) Welding

Flux Cored (FCAW)



Stick (SMAW) Welding



TIG (GTAW) Welding



Air Plasma Cutting and Gouging
with Spectrum[®] Unit



Air Carbon Arc (CAC-A) Cutting
and Gouging

Description



Engine Driven Welding Generator
(AC Available On AC/DC Models Only)

Trailblazer[®] 301 G

Trailblazer[®] DC

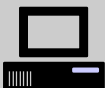
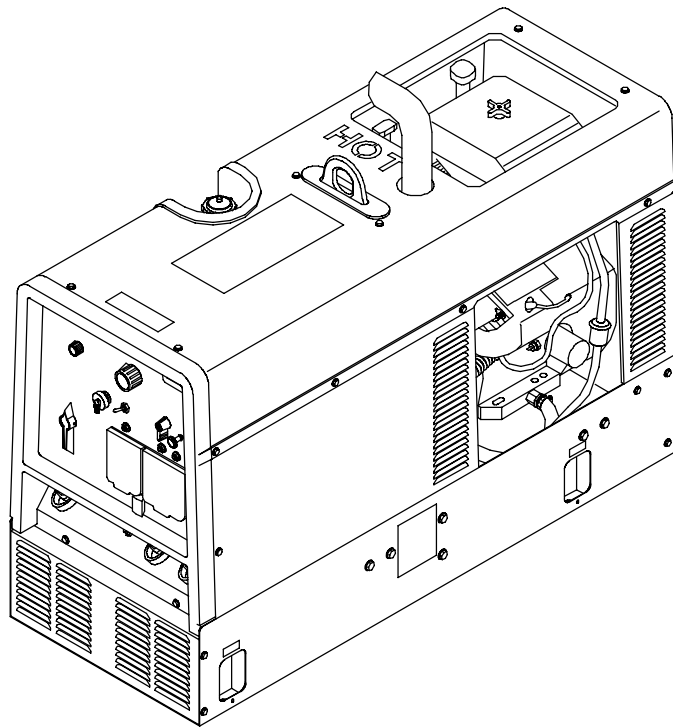

Visit our website at
www.MillerWelds.com

OWNER'S MANUAL

From Miller to You

Thank you and congratulations on choosing Miller. Now you can get the job done and get it done right. We know you don't have time to do it any other way.

That's why when Niels Miller first started building arc welders in 1929, he made sure his products offered long-lasting value and superior quality. Like you, his customers couldn't afford anything less. Miller products had to be more than the best they could be. They had to be the best you could buy.

Today, the people that build and sell Miller products continue the tradition. They're just as committed to providing equipment and service that meets the high standards of quality and value established in 1929.

This Owner's Manual is designed to help you get the most out of your Miller products. Please take time to read the Safety precautions. They will help you protect yourself against potential hazards on the worksite.

We've made installation and operation quick and easy. With Miller you can count on years of reliable service with proper maintenance. And if for some reason the unit needs repair, there's a Troubleshooting section that will help you figure out what the problem is. The parts list will then help you to decide the exact part you may need to fix the problem. Warranty and service information for your particular model are also provided.



Miller is the first welding equipment manufacturer in the U.S.A. to be registered to the ISO 9001:2000 Quality System Standard.



Miller Electric manufactures a full line of welders and welding related equipment. For information on other quality Miller products, contact your local Miller distributor to receive the latest full line catalog or individual catalog sheets. **To locate your nearest distributor or service agency call 1-800-4-A-Miller, or visit us at www.MillerWelds.com on the web.**



Working as hard as you do – every power source from Miller is backed by the most hassle-free warranty in the business.



TABLE OF CONTENTS

| | |
|---|-----------|
| SECTION 1 – SAFETY PRECAUTIONS – READ BEFORE USING | 1 |
| 1-1. Symbol Usage | 1 |
| 1-2. Arc Welding Hazards | 1 |
| 1-3. Engine Hazards | 2 |
| 1-4. Compressed Air Hazards | 3 |
| 1-5. Additional Symbols For Installation, Operation, And Maintenance | 3 |
| 1-6. California Proposition 65 Warnings | 4 |
| 1-7. Principal Safety Standards | 4 |
| 1-8. EMF Information | 4 |
| SECTION 2 – CONSIGNES DE SÉCURITÉ – LIRE AVANT UTILISATION | 5 |
| 2-1. Signification des symboles | 5 |
| 2-2. Dangers relatifs au soudage à l'arc | 5 |
| 2-3. Dangers existant en relation avec le moteur | 6 |
| 2-4. Dangers liés à l'air comprimé | 7 |
| 2-5. Dangers supplémentaires en relation avec l'installation, le fonctionnement et la maintenance | 7 |
| 2-6. Principales normes de sécurité | 8 |
| 2-7. Information sur les champs électromagnétiques | 8 |
| SECTION 3 – DEFINITIONS | 9 |
| 3-1. Symbol Definitions | 9 |
| SECTION 4 – SPECIFICATIONS | 10 |
| 4-1. Weld, Power, And Engine Specifications | 10 |
| 4-2. Dimensions, Weights, and Operating Angles | 10 |
| 4-3. Fuel Consumption While Welding | 11 |
| 4-4. Fuel Consumption While Using Generator Power | 11 |
| 4-5. Generator Power Curve | 12 |
| 4-6. Duty Cycle | 12 |
| 4-7. Stick And MIG Mode Volt-Ampere Curves | 13 |
| 4-8. TIG Mode Volt-Ampere Curves | 14 |
| SECTION 5 – INSTALLATION | 15 |
| 5-1. Installing Welding Generator | 15 |
| 5-2. Engine Prestart Checks (Robin EH64-Powered Units) | 16 |
| 5-3. Engine Prestart Checks (Kohler-Powered Units) | 17 |
| 5-4. Activating The Dry Charge Battery (If Applicable) | 18 |
| 5-5. Connecting The Battery | 19 |
| 5-6. Installing Exhaust Pipe | 19 |
| 5-7. Connecting To Weld Output Terminals | 20 |
| 5-8. Selecting Weld Cable Sizes* | 21 |
| 5-9. Remote Receptacle Information | 21 |
| 5-10. Adjusting Wire (MIG) Weld Puddle Consistency | 22 |
| SECTION 6 – OPERATING WELDING GENERATOR | 23 |
| 6-1. Front Panel Controls | 23 |
| 6-2. Process/Contactor Switch On CC/CV Models | 24 |
| 6-3. Remote Amperage/Voltage Control | 25 |
| SECTION 7 – OPERATING AUXILIARY EQUIPMENT | 26 |
| 7-1. Generator Power Receptacles And Circuit Breakers | 26 |
| 7-2. Optional Generator Power Receptacles | 27 |
| 7-3. Wiring Instructions For Optional 240 Volt, Single-Phase Plug (NEMA 14-50P) | 28 |

TABLE OF CONTENTS

| | |
|--|-----------|
| SECTION 8 – MAINTENANCE (Robin EH64-POWERED UNITS) | 29 |
| 8-1. Maintenance Label (Robin EH64-Powered Units) | 29 |
| 8-2. Routine Maintenance (Robin EH64-Powered Units) | 30 |
| 8-3. Servicing Air Cleaner (Robin EH64-Powered Units) | 32 |
| 8-4. Servicing Optional Spark Arrestor (Robin EH64-Powered Units) | 32 |
| 8-5. Overload Protection (Robin EH64-Powered Units) | 33 |
| 8-6. Changing Engine Oil, Oil Filter, and Fuel Filter (Robin EH64-Powered Units) | 34 |
| 8-7. Adjusting Engine Speed (Robin EH64-Powered Units) | 35 |
| SECTION 9 – MAINTENANCE (KOHLER-POWERED UNITS) | 36 |
| 9-1. Routine Maintenance (Kohler-Powered Units) | 36 |
| 9-2. Maintenance Label (Kohler-Powered Units) | 37 |
| 9-3. Servicing Air Cleaner (Kohler-Powered Units) | 38 |
| 9-4. Servicing Optional Spark Arrestor (Kohler-Powered Units) | 38 |
| 9-5. Changing Engine Oil, Oil Filter, And Fuel Filter (Kohler-Powered Units) | 39 |
| 9-6. Adjusting Engine Speed (Kohler-Powered Units) | 40 |
| 9-7. Overload Protection (Kohler-Powered Units) | 41 |
| SECTION 10 – TROUBLESHOOTING | 42 |
| 10-1. Welding Troubleshooting | 42 |
| 10-2. Generator Power Troubleshooting | 43 |
| 10-3. Engine Troubleshooting | 43 |
| SECTION 11 – ELECTRICAL DIAGRAMS | 46 |
| SECTION 12 – GENERATOR POWER GUIDELINES | 50 |
| SECTION 13 – PARTS LIST | 58 |
| OPTIONS AND ACCESSORIES | |
| WARRANTY | |

SECTION 1 – SAFETY PRECAUTIONS – READ BEFORE USING

rom_nd_10/02

▲ **Warning: Protect yourself and others from injury — read and follow these precautions.**

1-1. Symbol Usage



Means Warning! Watch Out! There are possible hazards with this procedure! The possible hazards are shown in the adjoining symbols.

▲ Marks a special safety message.

☞ Means “Note”; not safety related.



This group of symbols means Warning! Watch Out! possible ELECTRIC SHOCK, MOVING PARTS, and HOT PARTS hazards. Consult symbols and related instructions below for necessary actions to avoid the hazards.

1-2. Arc Welding Hazards

▲ **The symbols shown below are used throughout this manual to call attention to and identify possible hazards. When you see the symbol, watch out, and follow the related instructions to avoid the hazard. The safety information given below is only a summary of the more complete safety information found in the Safety Standards listed in Section 1-7. Read and follow all Safety Standards.**

▲ **Only qualified persons should install, operate, maintain, and repair this unit.**

▲ **During operation, keep everybody, especially children, away.**



ELECTRIC SHOCK can kill.

Touching live electrical parts can cause fatal shocks or severe burns. The electrode and work circuit is electrically live whenever the output is on. The input power circuit and machine internal circuits are also live when power is on. In semiautomatic or automatic wire welding, the wire, wire reel, drive roll housing, and all metal parts touching the welding wire are electrically live. Incorrectly installed or improperly grounded equipment is a hazard.

- Do not touch live electrical parts.
- Wear dry, hole-free insulating gloves and body protection.
- Insulate yourself from work and ground using dry insulating mats or covers big enough to prevent any physical contact with the work or ground.
- Do not use AC output in damp areas, if movement is confined, or if there is a danger of falling.
- Use AC output ONLY if required for the welding process.
- If AC output is required, use remote output control if present on unit.
- Additional safety precautions are required when any of the following electrically hazardous conditions are present: in damp locations or while wearing wet clothing; on metal structures such as floors, gratings, or scaffolds; when in cramped positions such as sitting, kneeling, or lying; or when there is a high risk of unavoidable or accidental contact with the workpiece or ground. For these conditions, use the following equipment in order presented: 1) a semiautomatic DC constant voltage (wire) welder, 2) a DC manual (stick) welder, or 3) an AC welder with reduced open-circuit voltage. In most situations, use of a DC, constant voltage wire welder is recommended. And, do not work alone!
- Disconnect input power or stop engine before installing or servicing this equipment. Lockout/tagout input power according to OSHA 29 CFR 1910.147 (see Safety Standards).
- Properly install and ground this equipment according to its Owner's Manual and national, state, and local codes.
- Always verify the supply ground — check and be sure that input power cord ground wire is properly connected to ground terminal in disconnect box or that cord plug is connected to a properly grounded receptacle outlet.
- When making input connections, attach proper grounding conductor first — double-check connections.
- Frequently inspect input power cord for damage or bare wiring — replace cord immediately if damaged — bare wiring can kill.
- Turn off all equipment when not in use.
- Do not use worn, damaged, undersized, or poorly spliced cables.
- Do not drape cables over your body.
- If earth grounding of the workpiece is required, ground it directly with a separate cable.
- Do not touch electrode if you are in contact with the work, ground, or another electrode from a different machine.

- Use only well-maintained equipment. Repair or replace damaged parts at once. Maintain unit according to manual.
- Wear a safety harness if working above floor level.
- Keep all panels and covers securely in place.
- Clamp work cable with good metal-to-metal contact to workpiece or worktable as near the weld as practical.
- Insulate work clamp when not connected to workpiece to prevent contact with any metal object.
- Do not connect more than one electrode or work cable to any single weld output terminal.

SIGNIFICANT DC VOLTAGE exists in inverters after stopping engine.

- Stop engine on inverter and discharge input capacitors according to instructions in Maintenance Section before touching any parts.



FUMES AND GASES can be hazardous.

Welding produces fumes and gases. Breathing these fumes and gases can be hazardous to your health.

- Keep your head out of the fumes. Do not breathe the fumes.
- If inside, ventilate the area and/or use exhaust at the arc to remove welding fumes and gases.
- If ventilation is poor, use an approved air-supplied respirator.
- Read the Material Safety Data Sheets (MSDSs) and the manufacturer's instructions for metals, consumables, coatings, cleaners, and degreasers.
- Work in a confined space only if it is well ventilated, or while wearing an air-supplied respirator. Always have a trained watchperson nearby. Welding fumes and gases can displace air and lower the oxygen level causing injury or death. Be sure the breathing air is safe.
- Do not weld in locations near degreasing, cleaning, or spraying operations. The heat and rays of the arc can react with vapors to form highly toxic and irritating gases.
- Do not weld on coated metals, such as galvanized, lead, or cadmium plated steel, unless the coating is removed from the weld area, the area is well ventilated, and if necessary, while wearing an air-supplied respirator. The coatings and any metals containing these elements can give off toxic fumes if welded.



BUILDUP OF GAS can injure or kill.

- Shut off shielding gas supply when not in use.
- Always ventilate confined spaces or use approved air-supplied respirator.

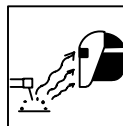

ARC RAYS can burn eyes and skin.

Arc rays from the welding process produce intense visible and invisible (ultraviolet and infrared) rays that can burn eyes and skin. Sparks fly off from the weld.

- Wear a welding helmet fitted with a proper shade of filter to protect your face and eyes from arc rays and sparks when welding or watching (see ANSI Z49.1 and Z87.1 listed in Safety Standards).
- Wear approved safety glasses with side shields under your helmet.
- Use protective screens or barriers to protect others from flash and glare; warn others not to watch the arc.
- Wear protective clothing made from durable, flame-resistant material (wool and leather) and foot protection.



WELDING can cause fire or explosion.

Welding on closed containers, such as tanks, drums, or pipes, can cause them to blow up. Sparks can fly off from the welding arc. The flying sparks, hot workpiece, and hot equipment can cause fires and burns. Accidental contact of electrode to metal objects can cause sparks, explosion, overheating, or fire. Check and be sure the area is safe before doing any welding.

- Protect yourself and others from flying sparks and hot metal.
- Do not weld where flying sparks can strike flammable material.
- Remove all flammables within 35 ft (10.7 m) of the welding arc. If this is not possible, tightly cover them with approved covers.
- Be alert that welding sparks and hot materials from welding can easily go through small cracks and openings to adjacent areas.
- Watch for fire, and keep a fire extinguisher nearby.
- Be aware that welding on a ceiling, floor, bulkhead, or partition can cause fire on the hidden side.
- Do not weld on closed containers such as tanks, drums, or pipes, unless they are properly prepared according to AWS F4.1 (see Safety Standards).
- Connect work cable to the work as close to the welding area as practical to prevent welding current from traveling long, possibly unknown paths and causing electric shock and fire hazards.
- Do not use welder to thaw frozen pipes.
- Remove stick electrode from holder or cut off welding wire at contact tip when not in use.
- Wear oil-free protective garments such as leather gloves, heavy shirt, cuffless trousers, high shoes, and a cap.
- Remove any combustibles, such as a butane lighter or matches, from your person before doing any welding.
- Follow requirements in OSHA 1910.252 (a) (2) (iv) and NFPA 51B for hot work and have a fire watcher and extinguisher nearby.

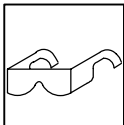

FLYING METAL can injure eyes.

- Welding, chipping, wire brushing, and grinding cause sparks and flying metal. As welds cool, they can throw off slag.
- Wear approved safety glasses with side shields even under your welding helmet.



HOT PARTS can cause severe burns.

- Allow cooling period before maintaining.
- Wear protective gloves and clothing when working on a hot engine.
- Do not touch hot engine parts or just-welded parts bare-handed.

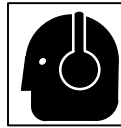

NOISE can damage hearing.

Noise from some processes or equipment can damage hearing.

- Wear approved ear protection if noise level is high.



MAGNETIC FIELDS can affect pacemakers.

- Pacemaker wearers keep away.
- Wearers should consult their doctor before going near arc welding, gouging, or spot welding operations.



CYLINDERS can explode if damaged.

Shielding gas cylinders contain gas under high pressure. If damaged, a cylinder can explode. Since gas cylinders are normally part of the welding process, be sure to treat them carefully.

- Protect compressed gas cylinders from excessive heat, mechanical shocks, slag, open flames, sparks, and arcs.
- Install cylinders in an upright position by securing to a stationary support or cylinder rack to prevent falling or tipping.
- Keep cylinders away from any welding or other electrical circuits.
- Never drape a welding torch over a gas cylinder.
- Never allow a welding electrode to touch any cylinder.
- Never weld on a pressurized cylinder — explosion will result.
- Use only correct shielding gas cylinders, regulators, hoses, and fittings designed for the specific application; maintain them and associated parts in good condition.
- Turn face away from valve outlet when opening cylinder valve.
- Keep protective cap in place over valve except when cylinder is in use or connected for use.
- Read and follow instructions on compressed gas cylinders, associated equipment, and CGA publication P-1 listed in Safety Standards.

1-3. Engine Hazards



BATTERY EXPLOSION can BLIND.

- Always wear a face shield, rubber gloves, and protective clothing when working on a battery.
- Stop engine before disconnecting or connecting battery cables or servicing battery.
- Do not allow tools to cause sparks when working on a battery.
- Do not use welder to charge batteries or jump start vehicles.
- Observe correct polarity (+ and -) on batteries.
- Disconnect negative (-) cable first and connect it last.



FUEL can cause fire or explosion.

- Stop engine and let it cool off before checking or adding fuel.
- Do not add fuel while smoking or if unit is near any sparks or open flames.
- Do not overfill tank — allow room for fuel to expand.
- Do not spill fuel. If fuel is spilled, clean up before starting engine.
- Dispose of rags in a fireproof container.
- Always keep nozzle in contact with tank when fueling.



MOVING PARTS can cause injury.

- Keep away from fans, belts, and rotors.
- Keep all doors, panels, covers, and guards closed and securely in place.
- Stop engine before installing or connecting unit.
- Have only qualified people remove guards or covers for maintenance and troubleshooting as necessary.
- To prevent accidental starting during servicing, disconnect negative (-) battery cable from battery.
- Keep hands, hair, loose clothing, and tools away from moving parts.
- Reinstall panels or guards and close doors when servicing is finished and before starting engine.
- Before working on generator, remove spark plugs or injectors to keep engine from kicking back or starting.
- Block flywheel so that it will not turn while working on generator components.



STEAM AND HOT COOLANT can burn.

- If possible, check coolant level when engine is cold to avoid scalding.
- Always check coolant level at overflow tank, if present on unit, instead of radiator (unless told otherwise in maintenance section or engine manual).
- If the engine is warm, checking is needed, and there is no overflow tank, follow the next two statements.
- Wear safety glasses and gloves and put a rag over radiator cap.
- Turn cap slightly and let pressure escape slowly before completely removing cap.



ENGINE EXHAUST GASES can kill.

- Use equipment outside in open, well-ventilated areas.
- If used in a closed area, vent engine exhaust outside and away from any building air intakes.

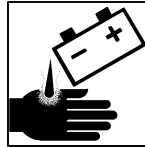

BATTERY ACID can BURN SKIN and EYES.

- Do not tip battery.
- Replace damaged battery.
- Flush eyes and skin immediately with water.



ENGINE HEAT can cause fire.

- Do not locate unit on, over, or near combustible surfaces or flammables.
- Keep exhaust and exhaust pipes way from flammables.



EXHAUST SPARKS can cause fire.

- Do not let engine exhaust sparks cause fire.
- Use approved engine exhaust spark arrestor in required areas — see applicable codes.

1-4. Compressed Air Hazards



BREATHING COMPRESSED AIR can cause serious injury or death.

- Do not use compressed air for breathing.
- Use only for cutting, gouging, and tools.

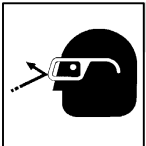

COMPRESSED AIR can cause injury.

- Wear approved safety goggles.
- Do not direct air stream toward self or others.



TRAPPED AIR PRESSURE AND WHIPPING HOSES can cause injury.

- Release air pressure from tools and system before servicing, adding or changing attachments, or opening compressor oil drain or oil fill cap.



HOT METAL from air arc cutting and gouging can cause fire or explosion.

- Do not cut or gouge near flammables.
- Watch for fire; keep extinguisher nearby.



HOT PARTS can cause burns and injury.

- Do not touch hot compressor or air system parts.
- Let system cool down before touching or servicing.

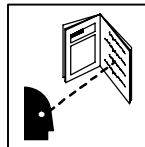

READ INSTRUCTIONS.

- Read Owner's Manual before using or servicing unit.
- Stop engine and release air pressure before servicing.

1-5. Additional Symbols For Installation, Operation, And Maintenance



FALLING UNIT can cause injury.

- Use lifting eye to lift unit only, NOT running gear, gas cylinders, trailer, or any other accessories.
- Use equipment of adequate capacity to lift and support unit.
- If using lift forks to move unit, be sure forks are long enough to extend beyond opposite side of unit.

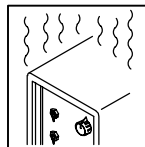

OVERUSE can cause OVERHEATING.

- Allow cooling period; follow rated duty cycle.
- Reduce current or reduce duty cycle before starting to weld again.
- Do not block or filter airflow to unit.

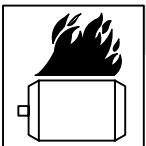

OVERHEATING can damage motors.

- Turn off or unplug equipment before starting or stopping engine.
- Do not let low voltage and frequency caused by low engine speed damage electric motors.
- Do not connect 50 or 60 Hertz motors to the 100 Hertz receptacle where applicable.

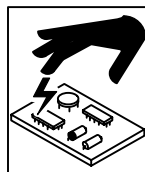

STATIC (ESD) can damage PC boards.

- Put on grounded wrist strap BEFORE handling boards or parts.
- Use proper static-proof bags and boxes to store, move, or ship PC boards.

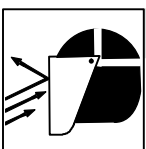

FLYING SPARKS can cause injury.

- Wear a face shield to protect eyes and face.
- Shape tungsten electrode only on grinder with proper guards in a safe location wearing proper face, hand, and body protection.
- Sparks can cause fires — keep flammables away.



TILTING OF TRAILER can cause injury.

- Use tongue jack or blocks to support weight.
- Properly install welding generator onto trailer according to instructions supplied with trailer.

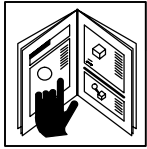

READ INSTRUCTIONS.

- Use only genuine MILLER/Hobart replacement parts.
- Perform engine and air compressor (if applicable) maintenance and service according to this manual and the engine/air compressor (if applicable) manuals.

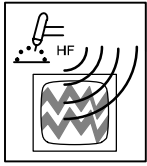

H.F. RADIATION can cause interference.

- High-frequency (H.F.) can interfere with radio navigation, safety services, computers, and communications equipment.
- Have only qualified persons familiar with electronic equipment perform this installation.
- The user is responsible for having a qualified electrician promptly correct any interference problem resulting from the installation.
- If notified by the FCC about interference, stop using the equipment at once.
- Have the installation regularly checked and maintained.
- Keep high-frequency source doors and panels tightly shut, keep spark gaps at correct setting, and use grounding and shielding to minimize the possibility of interference.

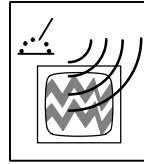

ARC WELDING can cause interference.

- Electromagnetic energy can interfere with sensitive electronic equipment such as microprocessors, computers, and computer-driven equipment such as robots.
- Be sure all equipment in the welding area is electromagnetically compatible.
- To reduce possible interference, keep weld cables as short as possible, close together, and down low, such as on the floor.
- Locate welding operation 100 meters from any sensitive electronic equipment.
- Be sure this welding machine is installed and grounded according to this manual.
- If interference still occurs, the user must take extra measures such as moving the welding machine, using shielded cables, using line filters, or shielding the work area.

1-6. California Proposition 65 Warnings

- ▲ **Welding or cutting equipment produces fumes or gases which contain chemicals known to the State of California to cause birth defects and, in some cases, cancer. (California Health & Safety Code Section 25249.5 et seq.)**
- ▲ **Battery posts, terminals and related accessories contain lead and lead compounds, chemicals known to the State of California to cause cancer and birth defects or other reproductive harm. Wash hands after handling.**

For Gasoline Engines:

- ▲ **Engine exhaust contains chemicals known to the State of California to cause cancer, birth defects, or other reproductive harm.**

For Diesel Engines:

- ▲ **Diesel engine exhaust and some of its constituents are known to the State of California to cause cancer, birth defects, and other reproductive harm.**

1-7. Principal Safety Standards

Safety in Welding, Cutting, and Allied Processes, ANSI Standard Z49.1, from American Welding Society, 550 N.W. LeJeune Rd, Miami FL 33126 (phone: 305-443-9353, website: www.aws.org).

Recommended Safe Practices for the Preparation for Welding and Cutting of Containers and Piping, American Welding Society Standard AWS F4.1, from American Welding Society, 550 N.W. LeJeune Rd, Miami, FL 33126 (phone: 305-443-9353, website: www.aws.org).

National Electrical Code, NFPA Standard 70, from National Fire Protection Association, P.O. Box 9101, 1 Battery March Park, Quincy, MA 02269-9101 (phone: 617-770-3000, website: www.nfpa.org and www.sparky.org).

Safe Handling of Compressed Gases in Cylinders, CGA Pamphlet P-1, from Compressed Gas Association, 1735 Jefferson Davis Highway, Suite 1004, Arlington, VA 22202-4102 (phone: 703-412-0900, website: www.cganet.com).

Code for Safety in Welding and Cutting, CSA Standard W117.2, from Canadian Standards Association, Standards Sales, 178 Rexdale Bou-

levard, Rexdale, Ontario, Canada M9W 1R3 (phone: 800-463-6727 or in Toronto 416-747-4044, website: www.csa-international.org).

Practice For Occupational And Educational Eye And Face Protection, ANSI Standard Z87.1, from American National Standards Institute, 11 West 42nd Street, New York, NY 10036-8002 (phone: 212-642-4900, website: www.ansi.org).

Standard for Fire Prevention During Welding, Cutting, and Other Hot Work, NFPA Standard 51B, from National Fire Protection Association, P.O. Box 9101, 1 Battery March Park, Quincy, MA 02269-9101 (phone: 617-770-3000, website: www.nfpa.org and www.sparky.org).

OSHA, Occupational Safety and Health Standards for General Industry, Title 29, Code of Federal Regulations (CFR), Part 1910, Subpart Q, and Part 1926, Subpart J, from U.S. Government Printing Office, Superintendent of Documents, P.O. Box 371954, Pittsburgh, PA 15250 (there are 10 Regional Offices—phone for Region 5, Chicago, is 312-353-2220, website: www.osha.gov).

1-8. EMF Information

Considerations About Welding And The Effects Of Low Frequency Electric And Magnetic Fields

Welding current, as it flows through welding cables, will cause electromagnetic fields. There has been and still is some concern about such fields. However, after examining more than 500 studies spanning 17 years of research, a special blue ribbon committee of the National Research Council concluded that: "The body of evidence, in the committee's judgment, has not demonstrated that exposure to power-frequency electric and magnetic fields is a human-health hazard." However, studies are still going forth and evidence continues to be examined. Until the final conclusions of the research are reached, you may wish to minimize your exposure to electromagnetic fields when welding or cutting.

To reduce magnetic fields in the workplace, use the following procedures:

1. Keep cables close together by twisting or taping them.
2. Arrange cables to one side and away from the operator.
3. Do not coil or drape cables around your body.
4. Keep welding power source and cables as far away from operator as practical.
5. Connect work clamp to workpiece as close to the weld as possible.

About Pacemakers:

Pacemaker wearers consult your doctor first. If cleared by your doctor, then following the above procedures is recommended.

SECTION 2 – CONSIGNES DE SÉCURITÉ – LIRE AVANT UTILISATION

rom_fre 8/03

▲ Avertissement: Protégez vous et les autres des blessures – lisez et suivez ces précautions.

2-1. Signification des symboles



Signifie Mise en garde ! Soyez vigilant ! Cette procédure présente des risques de danger ! Ceux-ci sont identifiés par des symboles adjacents aux directives.

▲ Identifie un message de sécurité particulier.

Signifie NOTA ; n'est pas relatif à la sécurité.



Ce groupe de symboles signifie Mise en garde ! Soyez vigilant ! Il y a des risques de danger reliés

aux CHOCS ÉLECTRIQUES, aux PIÈCES EN MOUVEMENT et aux PIÈCES CHAUDES. Reportez-vous aux symboles et aux directives ci-dessous afin de connaître les mesures à prendre pour éviter tout danger.

2-2. Dangers relatifs au soudage à l'arc

▲ Les symboles présentés ci-après sont utilisés tout au long du présent manuel pour attirer votre attention et identifier les risques de danger. Lorsque vous voyez un symbole, soyez vigilant et suivez les directives mentionnées afin d'éviter tout danger. Les consignes de sécurité présentées ci-après ne font que résumer l'information contenue dans les normes de sécurité énumérées à la section 2-6. Veuillez lire et respecter toutes ces normes de sécurité.

▲ L'installation, l'utilisation, l'entretien et les réparations ne doivent être confiés qu'à des personnes qualifiées.

▲ Au cours de l'utilisation, tenir toute personne à l'écart et plus particulièrement les enfants.



UN CHOC ÉLECTRIQUE peut tuer.

Un simple contact avec des pièces électriques peut provoquer une électrocution ou des blessures graves. L'électrode et le circuit de soudage sont sous tension dès que l'appareil est sur ON. Le circuit d'entrée et les circuits internes de l'appareil sont également sous tension à ce moment-là. En soudage semi-automatique ou automatique, le fil, le dévidoir, le logement des galets d'entraînement et les pièces métalliques en contact avec le fil de soudage sont sous tension. Des matériels mal installés ou mal mis à la terre présentent un danger.

- Ne jamais toucher les pièces électriques sous tension.
- Porter des gants et des vêtements de protection secs ne comportant pas de trous.
- S'isoler de la pièce et de la terre au moyen de tapis ou d'autres moyens isolants suffisamment grands pour empêcher le contact physique éventuel avec la pièce ou la terre.
- Ne pas se servir de source électrique à courant électrique dans les zones humides, dans des endroits confinés ou là où on risque de tomber.
- Se servir d'une source électrique à courant électrique UNIQUEMENT si le procédé de soudage le demande.
- Si l'utilisation d'une source électrique à courant électrique s'avère nécessaire, se servir de la fonction de télécommande si l'appareil en est équipé.
- Des précautions de sécurité supplémentaires sont requises dans des environnements à risque comme: les endroits humides ou lorsque l'on porte des vêtements mouillés; sur des structures métalliques au sol, grillages et échafaudages; dans des positions assises, à genoux et allongées; ou quand il y a un risque important de contact accidentel avec la pièce ou le sol. Dans ces cas utiliser les appareils suivants dans l'ordre de préférence: 1) un poste à souder DC semi-automatique de type CV (MIG/MAG), 2) un poste à souder manuel (électrode enrobée) DC, 3) un poste à souder manuel AC avec tension à vide réduite. Dans la plupart des cas, un poste courant continu de type CV est recommandé. Et, ne pas travailler seul!
- Couper l'alimentation ou arrêter le moteur avant de procéder à l'installation, à la réparation ou à l'entretien de l'appareil. Déverrouiller l'alimentation selon la norme OSHA 29 CFR 1910.147 (voir normes de sécurité).
- Installer et mettre à la terre correctement cet appareil conformément à son manuel d'utilisation et aux codes nationaux, provinciaux et municipaux.
- Toujours vérifier la terre du cordon d'alimentation – Vérifier et s'assurer que le fil de terre du cordon d'alimentation est bien raccordé à la borne de terre du sectionneur ou que la fiche du cordon est raccordée à une prise correctement mise à la terre.

- En effectuant les raccordements d'entrée fixer d'abord le conducteur de mise à la terre approprié et contre-vérifier les connexions.
- Vérifier fréquemment le cordon d'alimentation pour voir s'il n'est pas endommagé ou dénudé – remplacer le cordon immédiatement s'il est endommagé – un câble dénudé peut provoquer une électrocution.
- Mettre l'appareil hors tension quand on ne l'utilise pas.
- Ne pas utiliser des câbles usés, endommagés, de grosseur insuffisante ou mal épissés.
- Ne pas enrouler les câbles autour du corps.
- Si la pièce soudée doit être mise à la terre, le faire directement avec un câble distinct – ne pas utiliser le connecteur de pièce ou le câble de retour.
- Ne pas toucher l'électrode quand on est en contact avec la pièce, la terre ou une électrode provenant d'une autre machine.
- N'utiliser qu'un matériel en bon état. Réparer ou remplacer sur-le-champ les pièces endommagées. Entretien l'appareil conformément à ce manuel.
- Porter un harnais de sécurité quand on travaille en hauteur.
- Maintenir solidement en place tous les panneaux et capots.
- Fixer le câble de retour de façon à obtenir un bon contact métal-métal avec la pièce à souder ou la table de travail, le plus près possible de la soudure.
- Isoler la pince de masse quand pas mis à la pièce pour éviter le contact avec tout objet métallique.

Une tension DC importante subsiste à l'intérieur des onduleurs après avoir coupé l'alimentation.

- Couper l'alimentation du poste et décharger les condensateurs d'entrée comme indiqué dans la Section Maintenance avant de toucher des composants.

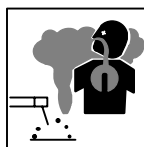

LES FUMÉES ET LES GAZ peuvent être dangereux.

Le soudage génère des fumées et des gaz. Leur inhalation peut être dangereuse pour votre santé.

- Eloigner votre tête des fumées. Ne pas respirer les fumées.
- À l'intérieur, ventiler la zone et/ou utiliser un échappement au niveau de l'arc pour l'évacuation des fumées et des gaz de soudage.
- Si la ventilation est insuffisante, utiliser un respirateur à alimentation d'air homologué.
- Lire les spécifications de sécurité des matériaux (MSDSs) et les instructions du fabricant concernant les métaux, les consommables, les revêtements, les nettoyeurs et les dégraisseurs.
- Travailler dans un espace fermé seulement s'il est bien ventilé ou en portant un respirateur à alimentation d'air. Demander toujours à un surveillant dûment formé de se tenir à proximité. Des fumées et des gaz de soudage peuvent déplacer l'air et abaisser le niveau d'oxygène provoquant des blessures ou des accidents mortels. S'assurer que l'air de respiration ne présente aucun danger.
- Ne pas souder dans des endroits situés à proximité d'opérations de dégraissage, de nettoyage ou de pulvérisation. La chaleur et les rayons de l'arc peuvent réagir en présence de vapeurs et former des gaz hautement toxiques et irritants.
- Ne pas souder des métaux munis d'un revêtement, tels que l'acier galvanisé, plaqué en plomb ou au cadmium à moins que le revêtement n'ait été enlevé dans la zone de soudure, que l'endroit soit bien ventilé, et si nécessaire, en portant un respirateur à alimentation d'air. Les revêtements et tous les métaux renfermant ces éléments peuvent dégager des fumées toxiques en cas de soudage.



LES ACCUMULATIONS DE GAZ risquent de provoquer des blessures ou même la mort.

- Fermer l'alimentation du gaz protecteur en cas de non utilisation.
- Veiller toujours à bien aérer les espaces confinés ou se servir d'un respirateur d'adduction d'air homologué.



LES RAYONS DE L'ARC peuvent provoquer des brûlures dans les yeux et sur la peau.

Le rayonnement de l'arc du procédé de soudage génère des rayons visibles et invisibles intenses (ultraviolets et infrarouges) susceptibles de provoquer des brûlures dans les yeux et sur la peau. Des étincelles sont projetées pendant le soudage.

- Porter un casque de soudage muni d'un écran de filtre approprié pour protéger votre visage et vos yeux pendant le soudage ou pour regarder (voir ANSI Z49.1 et Z87.1 énuméré dans les normes de sécurité).
- Porter des protections approuvés pour les oreilles si le niveau sonore est trop élevé.
- Utiliser des écrans ou des barrières pour protéger des tiers de l'éclair et de l'éblouissement; demander aux autres personnes de ne pas regarder l'arc.
- Porter des vêtements de protection constitué dans une matière durable, résistant au feu (laine ou cuir) et une protection des pieds.



LE SOUDAGE peut provoquer un incendie ou une explosion.

Le soudage effectué sur des conteneurs fermés tels que des réservoirs, tambours ou des conduites peut provoquer leur éclatement. Des étincelles peuvent être projetées de l'arc de soudure. La projection d'étincelles, des pièces chaudes et des équipements chauds peut provoquer des incendies et des brûlures. Le contact accidentel de l'électrode avec des objets métalliques peut provoquer des étincelles, une explosion, un surchauffement ou un incendie. Avant de commencer le soudage, vérifier et s'assurer que l'endroit ne présente pas de danger.

- Se protéger et d'autres personnes de la projection d'étincelles et de métal chaud.
- Ne pas souder dans un endroit là où des étincelles peuvent tomber sur des substances inflammables.
- Déplacer toutes les substances inflammables à une distance de 10,7 m de l'arc de soudage. En cas d'impossibilité les recouvrir soigneusement avec des protections homologués.
- Des étincelles et des matériaux chauds du soudage peuvent facilement passer dans d'autres zones en traversant de petites fissures et des ouvertures.
- Surveiller tout déclenchement d'incendie et tenir un extincteur à proximité.
- Le soudage effectué sur un plafond, plancher, paroi ou séparation peut déclencher un incendie de l'autre côté.
- Ne pas effectuer le soudage sur des conteneurs fermés tels que des réservoirs, tambours, ou conduites, à moins qu'ils n'aient été préparés correctement conformément à AWS F4.1 (voir les normes de sécurité).
- Brancher le câble sur la pièce le plus près possible de la zone de soudage pour éviter le transport du courant sur une longue distance par des chemins inconnus éventuels en provoquant des risques d'électrocution et d'incendie.
- Ne pas utiliser le poste de soudage pour dégeler des conduites gelées.
- En cas de non utilisation, enlever la baguette d'électrode du porte-électrode ou couper le fil à la pointe de contact.
- Porter des vêtements de protection dépourvus d'huile tels que des gants en cuir, une chemise en matériau lourd, des pantalons sans revers, des chaussures hautes et un couvre chef.
- Avant de souder, retirer toute substance combustible de vos poches telles qu'un allumeur au butane ou des allumettes.

2-3. Dangers existant en relation avec le moteur



LES ACCUMULATIONS DE GAZ risquent de provoquer des blessures ou même la mort.

- Fermer l'alimentation du gaz protecteur en cas de non utilisation.
- Veiller toujours à bien aérer les espaces confinés ou se servir d'un respirateur d'adduction d'air homologué.

- Suivre les recommandations dans OSHA 1910.252(a)(2)(iv) et NFPA 51B pour les travaux à chaud et avoir de la surveillance et un extincteur à proximité.

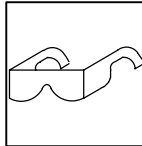

DES PARTICULES VOLANTES peuvent blesser les yeux.

- Le soudage, l'écaillage, le passage de la pièce à la brosse en fil de fer, et le meulage génèrent des étincelles et des particules métalliques volantes. Pendant la période de refroidissement des soudures, elles risquent de projeter du laitier.

- Porter des lunettes de sécurité avec écrans latéraux ou un écran facial.



DES PIÈCES CHAUDES peuvent provoquer des brûlures graves.

- Prévoir une période de refroidissement avant d'effectuer des travaux d'entretien.
- Porter des gants et des vêtements de protection pour travailler sur un moteur chaud.

- Ne pas toucher à mains nues les parties chaudes du moteur ni les pièces récemment soudées.

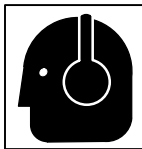

LE BRUIT peut affecter l'ouïe.

Le bruit des processus et des équipements peut affecter l'ouïe.

- Porter des protections approuvés pour les oreilles si le niveau sonore est trop élevé.

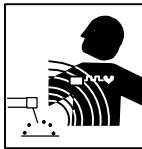

LES CHAMPS MAGNÉTIQUES peuvent affecter les stimulateurs cardiaques.

- Porteurs de stimulateur cardiaque, restez à distance.
- Les porteurs d'un stimulateur cardiaque doivent d'abord consulter leur médecin avant de s'approcher des opérations de soudage à l'arc, de gougeage ou de soudage par points.

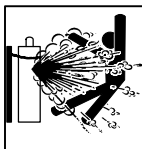

Si des BOUTEILLES sont endommagées, elles pourront exploser.

Des bouteilles de gaz protecteur contiennent du gaz sous haute pression. Si une bouteille est endommagée, elle peut exploser. Du fait que les bouteilles de gaz font normalement partie du procédé de soudage, les manipuler avec précaution.

- Protéger les bouteilles de gaz comprimé d'une chaleur excessive, des chocs mécaniques, du laitier, des flammes ouvertes, des étincelles et des arcs.
- Placer les bouteilles debout en les fixant dans un support stationnaire ou dans un porte-bouteilles pour les empêcher de tomber ou de se renverser.
- Tenir les bouteilles éloignées des circuits de soudage ou autres circuits électriques.
- Ne jamais placer une torche de soudage sur une bouteille à gaz.
- Une électrode de soudage ne doit jamais entrer en contact avec une bouteille.
- Ne jamais souder une bouteille pressurisée – risque d'explosion.
- Utiliser seulement des bouteilles de gaz protecteur, régulateurs, tuyaux et raccords convenables pour cette application spécifique; les maintenir ainsi que les éléments associés en bon état.
- Ne pas tenir la tête en face de la sortie en ouvrant la soupape de la bouteille.
- Maintenir le chapeau de protection sur la soupape, sauf en cas d'utilisation ou de branchement de la bouteille.
- Lire et suivre les instructions concernant les bouteilles de gaz comprimé, les équipements associés et les publication P-1 CGA énumérées dans les normes de sécurité.



L'ACIDE DE LA BATTERIE peut provoquer des brûlures dans les YEUX et sur la PEAU.

- Ne pas renverser la batterie.
- Remplacer une batterie endommagée.
- Rincer immédiatement les yeux et la peau à l'eau.



L'EXPLOSION DE LA BATTERIE peut RENDRE AVEUGLE.

- Toujours porter une protection faciale, des gants en caoutchouc et vêtements de protection lors d'une intervention sur la batterie.
- Arrêter le moteur avant de débrancher ou de brancher les câbles de batterie.
- Eviter de provoquer des étincelles avec les outils en travaillant sur la batterie.
- Ne pas utiliser le poste de soudage pour charger les batteries ou des véhicules de démarrage rapide.
- Observer la polarité correcte (+ et -) sur les batteries.
- Débrancher le câble négatif (-) en premier lieu. Le rebrancher en dernier lieu.



LE CARBURANT MOTEUR peut provoquer un incendie ou une explosion.

- Arrêter le moteur avant de vérifier le niveau de carburant ou de faire le plein.
- Ne pas faire le plein en fumant ou proche d'une source d'étincelles ou d'une flamme nue.
- Ne pas faire le plein de carburant à ras bord; prévoir de l'espace pour son expansion.
- Faire attention de ne pas renverser de carburant. Nettoyer tout carburant renversé avant de faire démarrer le moteur.
- Jeter les chiffons dans un récipient ignifuge.



DES ORGANES MOBILES peuvent provoquer des blessures.

- Ne pas approcher les mains des ventilateurs, courroies et autres pièces en mouvement.
- Maintenir fermés et fixement en place les portes, panneaux, recouvrements et dispositifs de protection.
- Arrêter le moteur avant d'installer ou brancher l'appareil.
- Demander seulement à un personnel qualifié d'enlever les dispositifs de sécurité ou les recouvrements pour effectuer, s'il y a lieu, des travaux d'entretien et de dépannage.

2-4. Dangers liés à l'air comprimé



RESPIRER L'AIR COMPRIMÉ peut provoquer des blessures graves ou causer la mort.

- Ne pas utiliser l'air comprimé pour respirer.
- Utiliser l'air comprimé seulement pour le coupage, gougeage et les outils pneumatiques.

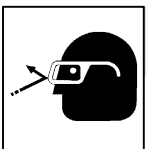

L'AIR COMPRIMÉ peut provoquer des blessures.

- Porter des lunettes de sécurité approuvées.
- Ne pas diriger le jet d'air vers d'autres ou soi-même.

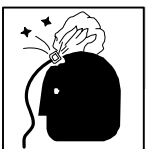

L'AIR COMPRIMÉ EMMAGASINE ET DES TUYAUX SOUS PRESSION peuvent provoquer des blessures.

- Relâcher la pression d'air de l'outillage ou du système avant d'effectuer la maintenance, avant de changer ou de rajouter des éléments ou avant d'ouvrir la purge ou le bouchon de remplissage d'huile.

- Pour empêcher tout démarrage accidentel pendant les travaux d'entretien, débrancher le câble négatif (-) de batterie de la borne.
- Ne pas approcher les mains, cheveux, vêtements lâches et outils des organes mobiles.
- Remettre en place les panneaux ou les dispositifs de protection et fermer les portes à la fin des travaux d'entretien et avant de faire démarrer le moteur.
- Avant d'intervenir, déposer les bougies ou injecteurs pour éviter la mise en route accidentelle du moteur.
- Bloquer le volant moteur pour éviter sa rotation lors d'une intervention sur le générateur.

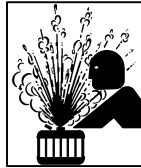

LA VAPEUR ET LE LIQUIDE DE REFROIDISSEMENT CHAUD peuvent provoquer des brûlures.

- Il est préférable de vérifier le liquide de refroidissement une fois le moteur refroidi pour éviter de se brûler.

- Toujours vérifier le niveau de liquide de refroidissement dans le vase d'expansion (si présent), et non dans le radiateur (sauf si précisé autrement dans la section maintenance du manuel du moteur).
- Si le moteur est chaud et que le liquide doit être vérifié, opérer comme suivant :
- Mettre des lunettes de sécurité et des gants, placer un torchon sur le bouchon du radiateur.
- Dévisser le bouchon légèrement et laisser la vapeur s'échapper avant d'enlever le bouchon.



LA CHALEUR DU MOTEUR peut provoquer un incendie.

- Ne pas placer l'appareil sur, au-dessus ou à proximité de surfaces inflammables.
- Tenir à distance les produits inflammables de l'échappement.



LES ÉTINCELLES À L'ÉCHAPPEMENT peuvent provoquer un incendie.

- Empêcher les étincelles d'échappement du moteur de provoquer un incendie.
- Utiliser uniquement un pare-étincelles approuvé - voir codes en vigueur.

2-5. Dangers supplémentaires en relation avec l'installation, le fonctionnement et la maintenance



LA CHUTE DE L'APPAREIL peut blesser.

- Utiliser l'anneau de levage uniquement pour soulever l'appareil lui-même ; sans chariot, de bouteilles de gaz, remorque, ou autres accessoires.

- Utiliser un équipement de levage de capacité suffisante pour lever l'appareil.
- En utilisant des fourches de levage pour déplacer l'unité, s'assurer que les fourches sont suffisamment longues pour dépasser du côté opposé de l'appareil.

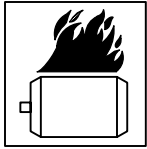

LE SURCHAUFFEMENT peut endommager le moteur électrique.

- Arrêter ou déconnecter l'équipement avant de démarrer ou d'arrêter le moteur.
- Ne pas laisser tourner le moteur trop lentement sous risque d'endommager le moteur électrique à cause d'une tension et d'une fréquence trop faibles.
- Ne pas brancher de moteur de 50 ou de 60 Hz à la prise de 100 Hz, s'il y a lieu.

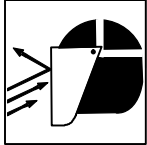

LES ÉTINCELLES VOLANTES risquent de provoquer des blessures.

- Porter un écran facial pour protéger le visage et les yeux.
- Affûter l'électrode au tungstène uniquement à la meuleuse dotée de protecteurs. Cette manoeuvre est à exécuter dans un endroit sûr lorsque l'on porte l'équipement homologué de protection du visage, des mains et du corps.
- Les étincelles risquent de causer un incendie – éloigner toute substance inflammable.

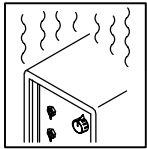

L'EMPLOI EXCESSIF peut SURCHAUFFER L'ÉQUIPEMENT.

- Laisser l'équipement refroidir ; respecter le facteur de marche nominal.
- Réduire le courant ou le facteur de marche avant de poursuivre le soudage.
- Ne pas obstruer les passages d'air du poste.

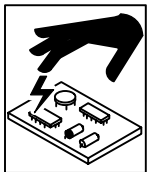

LES CHARGES ÉLECTROSTATIQUES peuvent endommager les circuits imprimés.

- Établir la connexion avec la barrette de terre avant de manipuler des cartes ou des pièces.
- Utiliser des pochettes et des boîtes antistatiques pour stocker, déplacer ou expédier des cartes de circuits imprimés.



UNE REMORQUE QUI BASCULE peut entraîner des blessures.

- Utiliser les supports de la remorque ou des blocs pour soutenir le poids.
- Installer convenablement le poste sur la remorque comme indiqué dans le manuel s'y rapportant.

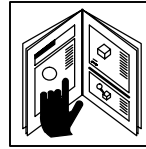

LIRE LES INSTRUCTIONS.

- Utiliser seulement les pièces de rechange d'origine.
- Effectuer la maintenance du moteur et du compresseur (si applicable) suivant ce manuel et le manuel du moteur/compresseur (si applicable).

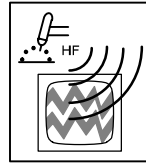

LE RAYONNEMENT HAUTE FRÉQUENCE (H.F.) risque de provoquer des interférences.

- Le rayonnement haute fréquence (H.F.) peut provoquer des interférences avec les équipements de radio-navigation et de communication, les services de sécurité et les ordinateurs.
- Demander seulement à des personnes qualifiées familiarisées avec des équipements électroniques de faire fonctionner l'installation.
- L'utilisateur est tenu de faire corriger rapidement par un électricien qualifié les interférences résultant de l'installation.
- Si le FCC signale des interférences, arrêter immédiatement l'appareil.
- Effectuer régulièrement le contrôle et l'entretien de l'installation.
- Maintenir soigneusement fermés les portes et les panneaux des sources de haute fréquence, maintenir les éclateurs à une distance correcte et utiliser une terre et un blindage pour réduire les interférences éventuelles.

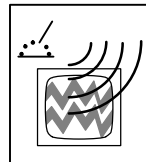

LE SOUDAGE À L'ARC risque de provoquer des interférences.

- L'énergie électromagnétique risque de provoquer des interférences pour l'équipement électronique sensible tel que les ordinateurs et l'équipement commandé par ordinateur tel que les robots.
- Veiller à ce que tout l'équipement de la zone de soudage soit compatible électromagnétiquement.
- Pour réduire la possibilité d'interférence, maintenir les câbles de soudage aussi courts que possible, les grouper, et les poser aussi bas que possible (ex. par terre).
- Veiller à souder à une distance de 100 mètres de tout équipement électronique sensible.
- Veiller à ce que ce poste de soudage soit posé et mis à la terre conformément à ce mode d'emploi.
- En cas d'interférences après avoir pris les mesures précédentes, il incombe à l'utilisateur de prendre des mesures supplémentaires telles que le déplacement du poste, l'utilisation de câbles blindés, l'utilisation de filtres de ligne ou la pose de protecteurs dans la zone de travail.

2-6. Principales normes de sécurité

Safety in Welding, Cutting, and Allied Processes, norme ANSI Z49.1, de l'American Welding Society, 550 N.W. LeJeune Rd, Miami FL 33126 (téléphone : (305) 443-9353, site Web : www.aws.org).

Recommended Safe Practices for the Preparation for Welding and Cutting of Containers and Piping, norme American Welding Society AWS F4.1, de l'American Welding Society, 550 N.W. LeJeune Rd, Miami, FL 33126 (téléphone : (305) 443-9353, site Web : www.aws.org).

National Electrical Code, norme NFPA 70, de la National Fire Protection Association, P.O. Box 9101, 1 Battery March Park, Quincy, MA 02269-9101 (téléphone : (617) 770-3000, sites Web : www.nfpa.org et www.sparky.org).

Safe Handling of Compressed Gases in Cylinders, brochure CGA P-1, de la Compressed Gas Association, 1735 Jefferson Davis Highway, Suite 1004, Arlington, VA 22202-4102 (téléphone : (703) 412-0900, site Web : www.cganet.com).

Code for Safety in Welding and Cutting, norme CSA W117.2, de la Canadian Standards Association, Standards Sales, 178 boulevard Rexdale,

Rexdale (Ontario) Canada M9W 1R3 (téléphone : (800) 463-6727 ou à Toronto : (416) 747-4044, site Web : www.csa-international.org).

Practice For Occupational And Educational Eye And Face Protection, norme ANSI Z87.1, de l'American National Standards Institute, 11 West 42nd Street, New York, NY 10036-8002 (téléphone : (212) 642-4900, site Web : www.ansi.org).

Standard for Fire Prevention During Welding, Cutting, and Other Hot Work, norme NFPA 51B, de la National Fire Protection Association, P.O. Box 9101, 1 Battery March Park, Quincy, MA 02269-9101 (téléphone : (617) 770-3000, site Web : www.nfpa.org et www.sparky.org).

OSHA, Occupational Safety and Health Standards for General Industry, Title 29, Code of Federal Regulations (CFR), Part 1910, Subpart Q, and Part 1926, Subpart J, de l'U.S. Government Printing Office, Superintendent of Documents, P.O. Box 371954, Pittsburgh, PA 15250 (il y a 10 bureaux régionaux – Téléphone pour la Région 5, Chicago : (312) 353-2220, site Web : www.osha.gov).

2-7. Information sur les champs électromagnétiques

Données sur le soudage électrique et les effets des champs magnétiques basse fréquence sur l'organisme

En parcourant les câbles de soudage, le courant crée des champs électromagnétiques. Les effets potentiels de tels champs restent préoccupants. Cependant, après avoir examiné plus de 500 études qui ont été faites pendant une période de recherche de 17 ans, un comité de spécialistes du National Research Council a conclu : « L'accumulation de preuves n'a pas démontré que l'exposition aux champs magnétiques et aux champs électriques à haute fréquence constitue un risque pour la santé humaine ». Toutefois, les études et l'examen des preuves se poursuivent. En attendant les conclusions finales de la recherche, il serait souhaitable de réduire l'exposition aux champs électromagnétiques pendant le soudage ou le coupage.

Afin de réduire les champs électromagnétiques en milieu de travail, respecter les consignes suivantes :

1. Garder les câbles ensemble en les torsadant ou en les fixant avec du ruban adhésif.
2. Mettre tous les câbles du côté opposé à l'opérateur.
3. Ne pas s'enrouler les câbles autour du corps.
4. Garder le poste de soudage et les câbles le plus loin possible de soi.
5. Placer la pince de masse le plus près possible de la zone de soudage.

Consignes relatives aux stimulateurs cardiaques :

Les personnes qui portent un stimulateur cardiaque doivent avant tout consulter leur médecin. Si ce dernier les déclare aptes, il leur est recommandé de respecter les consignes ci-dessus.

SECTION 3 – DEFINITIONS

3-1. Symbol Definitions

| | | | | | | | |
|----------|--------------------------------|----------|---------------------------|----------|-----------------------------|-----------|------------------------------|
| | Stop Engine | | Fast (Run, Weld/Power) | | Fast/Slow (Run/Idle) | | Slow (Idle) |
| | Start Engine | | Panel/Local | | Temperature | | Fuel |
| | Engine Oil | | Engine Choke | | Check Valve Clearance | | Battery (Engine) |
| | Engine | | Read Operator's Manual | A | Amperes | V | Volts |
| | MIG (GMAW), Wire | | Stick (SMAW) | | TIG (GTAW) | | Circuit Breaker |
| + | Positive | - | Negative | | Alternating Current (AC) | | Output |
| | Time | h | Hours | s | Seconds | | Protective Earth (Ground) |
| | Do not switch while welding | | Remote Receptacle | | Work Connection | CC | Constant Current |
| | Wire Feed | | Electrode Positive | | Electrode Negative | CV | Constant Voltage |

Notes

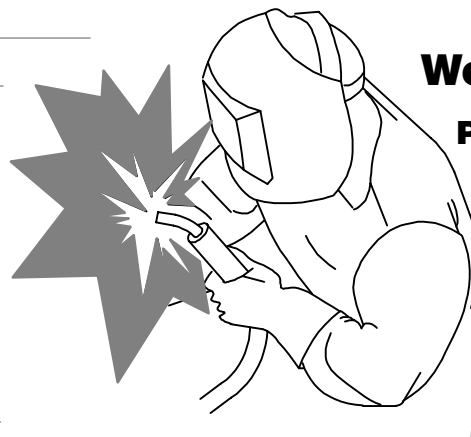

Work like a Pro!

Pros weld and cut safely. Read the safety rules at the beginning of this manual.

SECTION 4 – SPECIFICATIONS

4-1. Weld, Power, And Engine Specifications

| Welding Mode | Rated Welding Output | Maximum Open-Circuit Voltage | Amperage Range In CC Mode | Voltage Range In CV Mode | Generator Power Rating | Fuel Capacity | Engine |
|--------------|------------------------------|------------------------------|---------------------------|--------------------------|--|--------------------|--|
| CC/DC | 280 A, 25 V, 100% Duty Cycle | 80 | 20 – 300 A | 10 – 34 V | Continuous: 9.5 kVA/kW, 80/40 A, 120/240 V AC, 60 Hz, Single-Phase, Peak: 10 kVA/kW (w/Weld Contactor Off) | 10 gal (38 L) Tank | Robin EH64 Performer OHV Air-Cooled, Two-Cylinder, Four-Cycle, 20.5 HP Gasoline Engine or Kohler CH-20 Air-Cooled, Two-Cylinder, Four-Cycle, 20 HP Gasoline Engine |
| CV/DC | 300 A, 25 V, 100% Duty Cycle | 50 | 10 – 33 V Min – 325 A | | | | |
| CC/AC* | 200 A, 25 V, 60% Duty Cycle | 75 | 35 – 225 A | | | | |

* AC/DC Models Only.

4-2. Dimensions, Weights, and Operating Angles

| Dimensions | |
|---|-----------------------|
| Height | 33 in (838 mm) |
| Width | 18-3/4 in (476 mm) |
| Depth | 45-1/2 in (1156 mm) |
| A | 18 in (457 mm) |
| B | 16-1/2 in (419 mm) |
| C | 3/4 in (19 mm) |
| D | 3-1/8 in (79 mm) |
| E | 32-3/4 in (832 mm) |
| F | 45-1/2 in (1156 mm) |
| G | 13/32 in (10 mm) Dia. |
| Weight | |
| Robin: 591 lb (268 kg) Kohler: 567 lb (257 kg) | |

Engine End

- ▲ Do not exceed tilt angles or engine could be damaged or unit could tip.
- ▲ Do not move or operate unit where it could tip.

800 426

802 848-A

4-3. Fuel Consumption While Welding

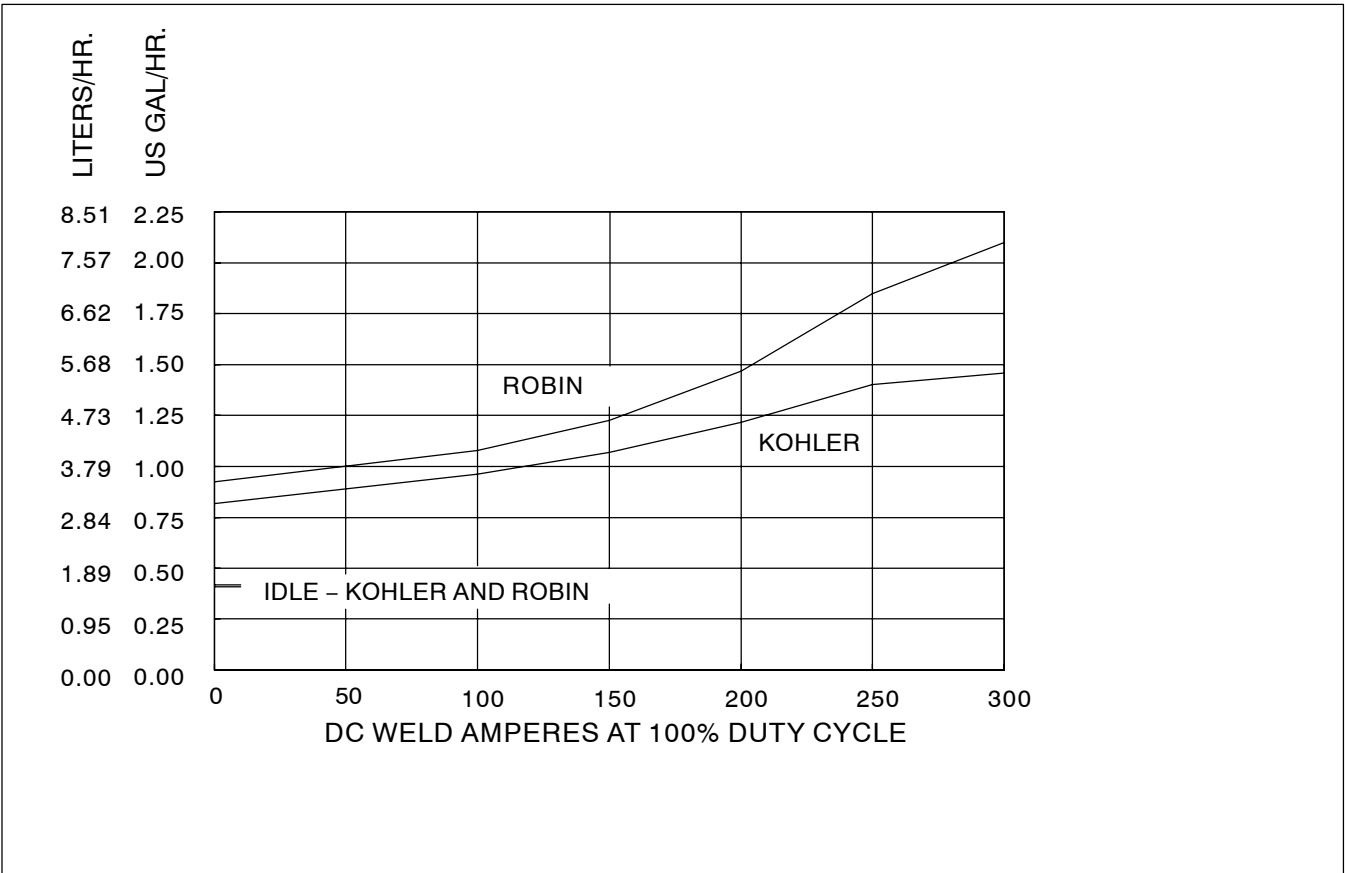

4-4. Fuel Consumption While Using Generator Power

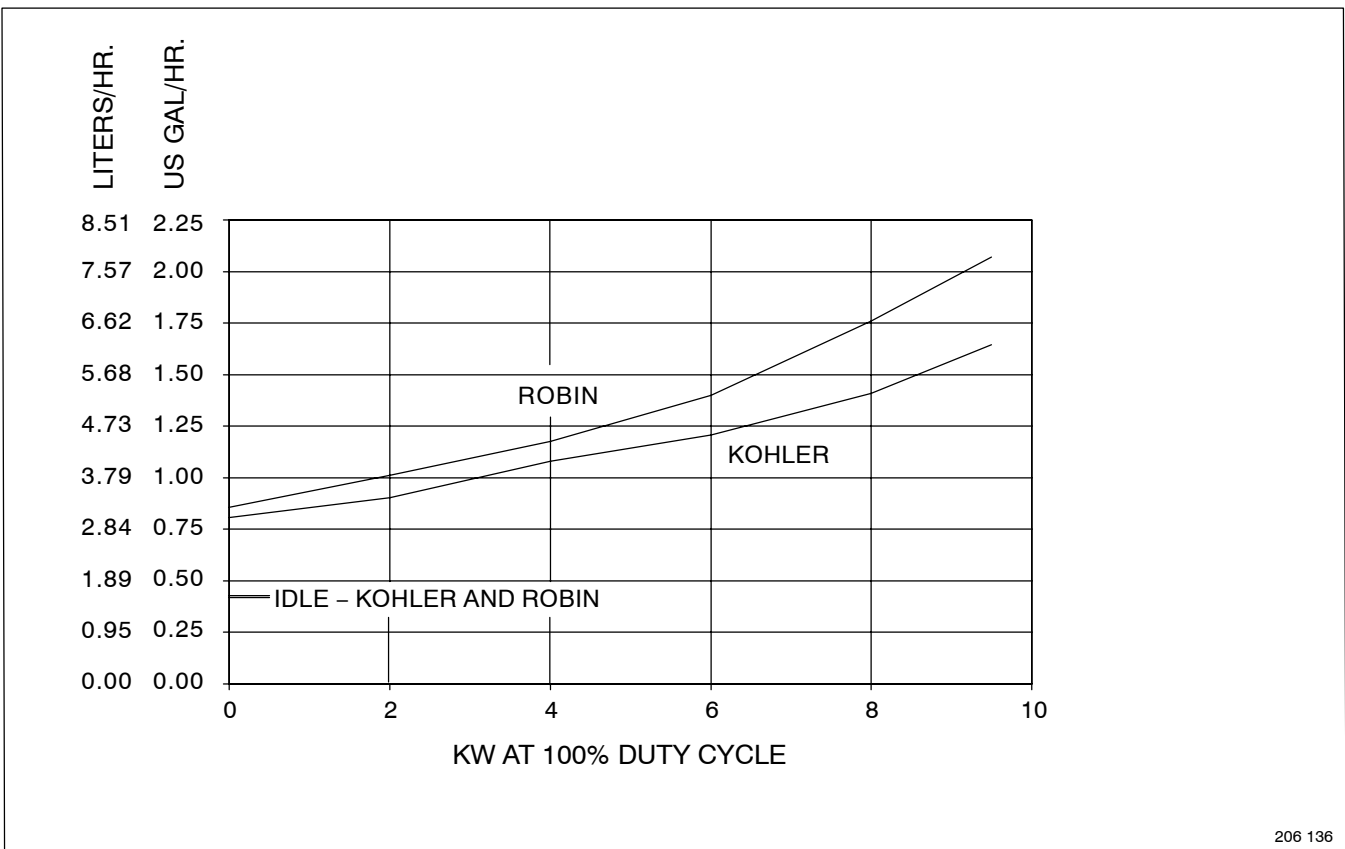

4-5. Generator Power Curve

The ac generator power curve shows the generator power available in amperes at the receptacles.

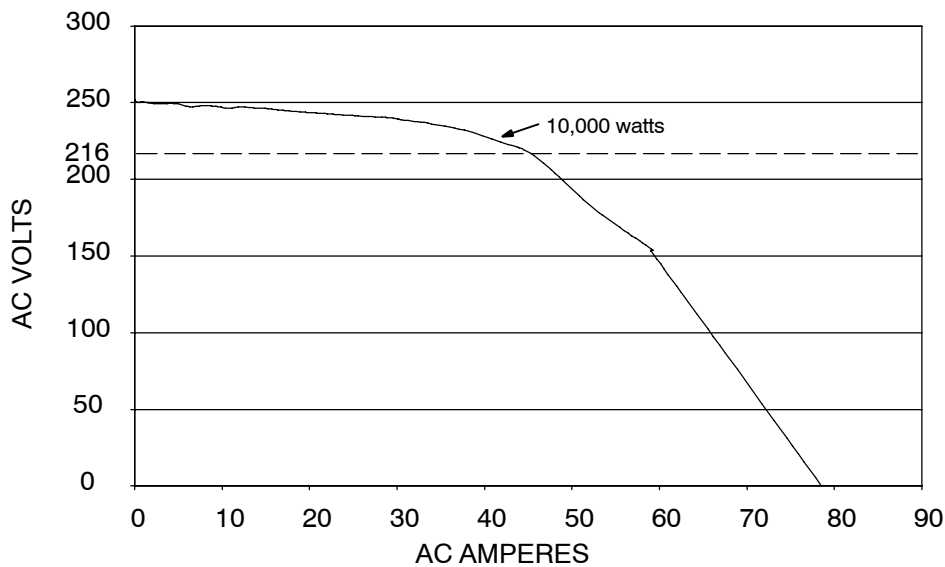

Ref. 204 922

4-6. Duty Cycle



100% Duty Cycle at 280 Amperes DC

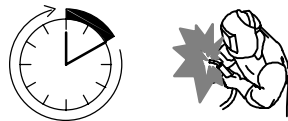

Continuous Welding

Duty cycle is the percentage of 10 minutes that unit can weld at rated load without overheating.

▲ Exceeding duty cycle can damage unit and void warranty.

☞ AC output is not available on all models.

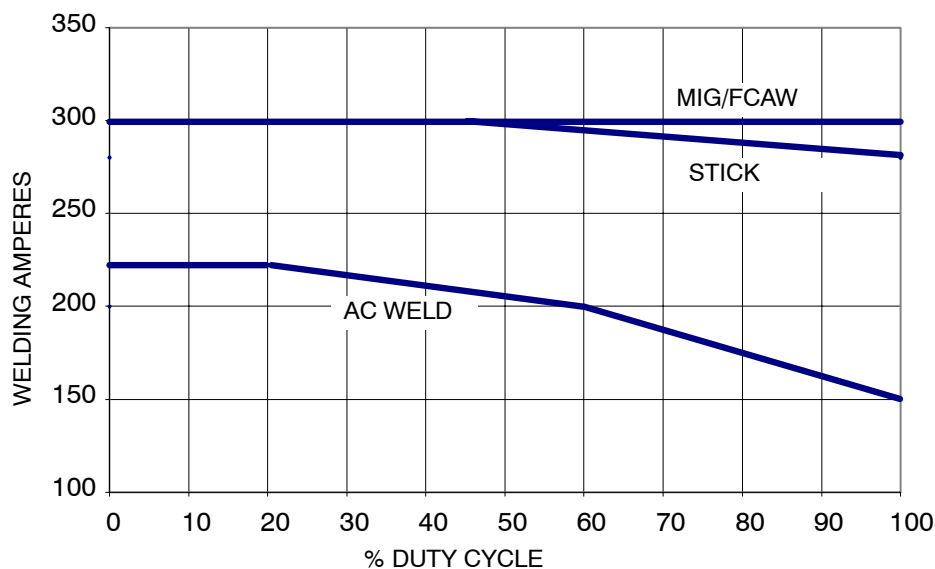

4-7. Stick And MIG Mode Volt-Ampere Curves

A. CC/AC Stick Mode

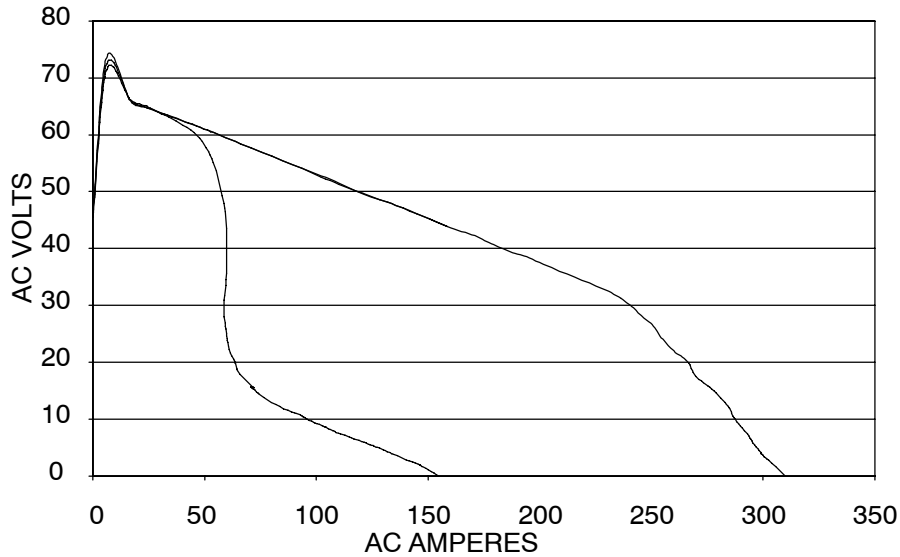

The volt-ampere curves show the minimum and maximum voltage and amperage output capabilities of the welding generator. Curves of other settings fall between the curves shown.

AC output is not available on all models.

B. CC/DC Stick Mode

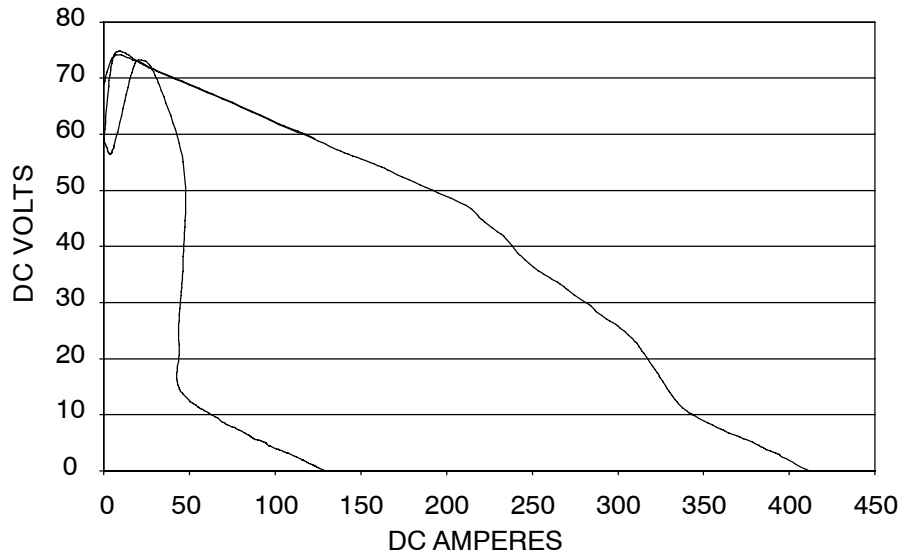

C. CV/DC MIG Mode

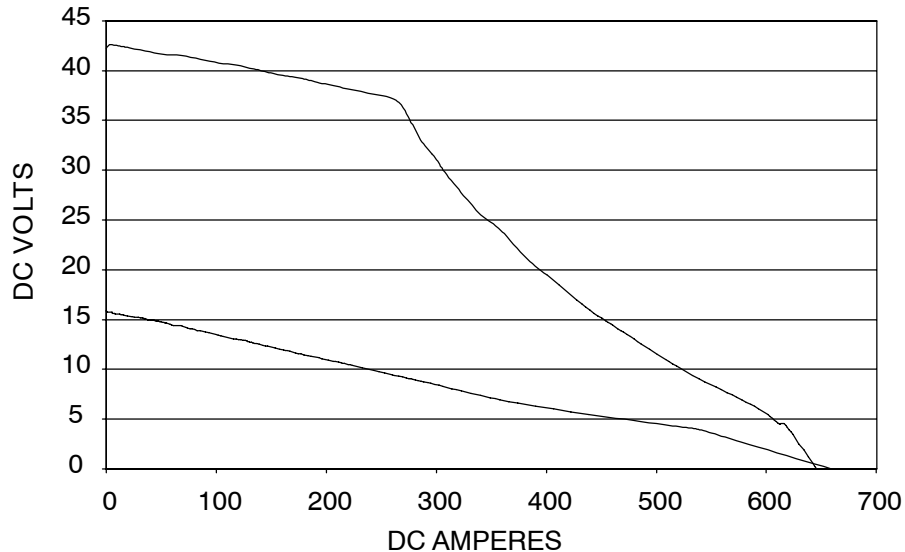

4-8. TIG Mode Volt-Ampere Curves

A. CC/AC TIG Mode

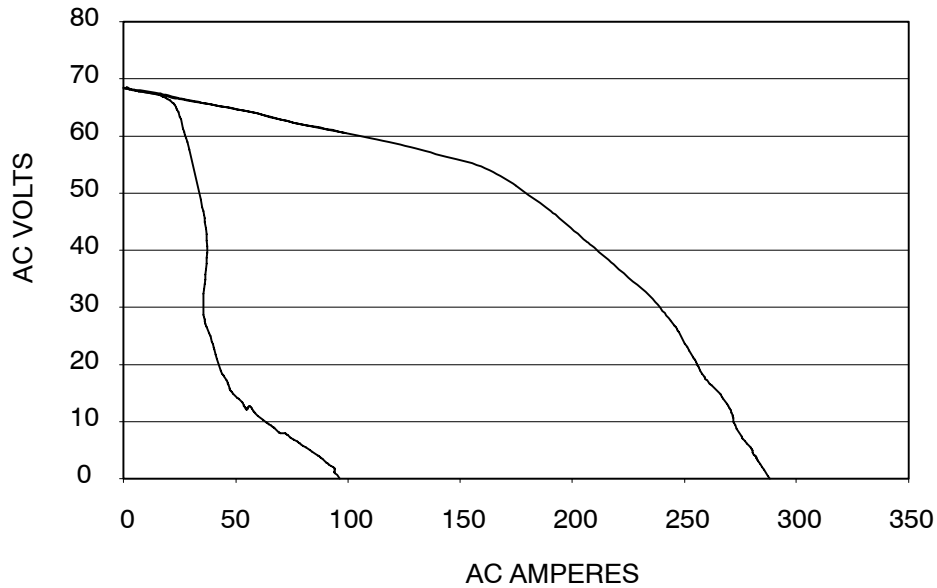

The volt-ampere curves show the minimum and maximum voltage and amperage output capabilities of the welding generator. Curves of other settings fall between the curves shown.

 AC output is not available on all models.

B. CC/DC TIG Mode

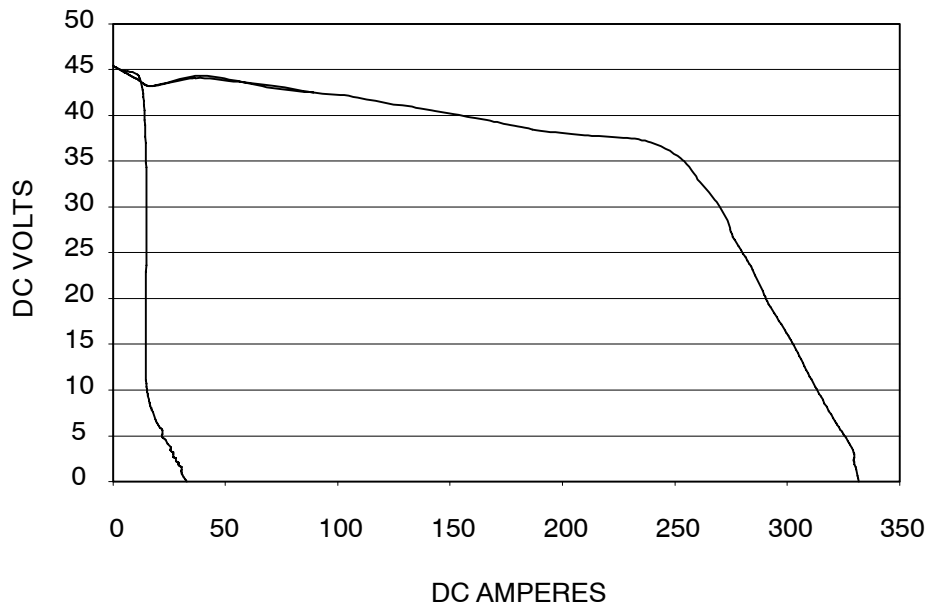

SECTION 5 – INSTALLATION

5-1. Installing Welding Generator



Movement

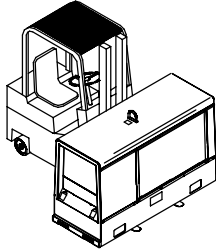

▲ Do not lift unit from end.

OR

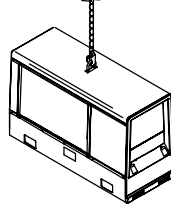

Location

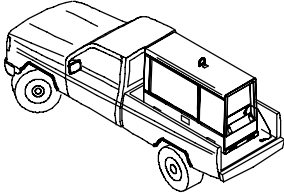

OR

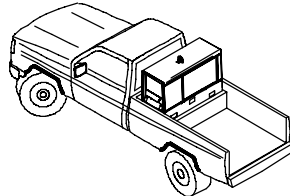

OR

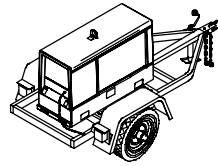

Mounting

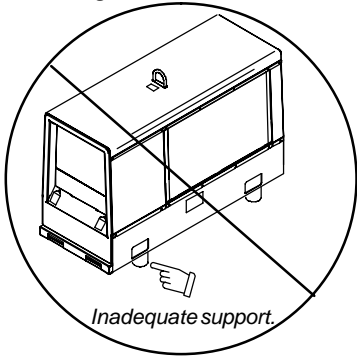

▲ Do not use flexible mounts.

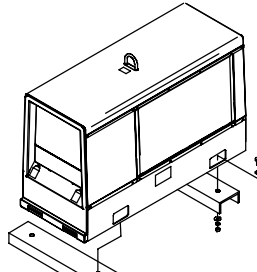

OR

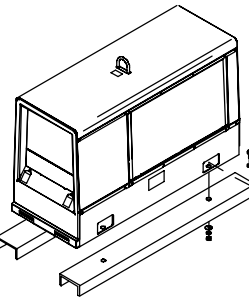

- ▲ Do not weld on base. Welding on base can cause fuel tank fire or explosion. Bolt unit down using holes provided in base.
- ▲ Always securely fasten welding generator onto transport vehicle or trailer and comply with all DOT and other applicable codes.
- ▲ Do not mount unit by supporting the base only at the four mounting holes. Use cross-supports to adequately support unit and prevent damage to base.
- ▲ Always ground generator frame to prevent electric shock and static electricity hazards.
- ▲ If unit does not have GFCI receptacles, use GFCI-protected extension cord.

Mounting:

- 1 Cross-Supports

Mount unit on flat surface or use cross-supports to support base.

Grounding:

- 2 Equipment Grounding Terminal (On Front Panel)
- 3 Grounding Cable (Not Supplied)
- 4 Metal Vehicle Frame

Connect cable from equipment ground terminal to metal vehicle frame. Use #10 AWG or larger insulated copper wire.

Grounding

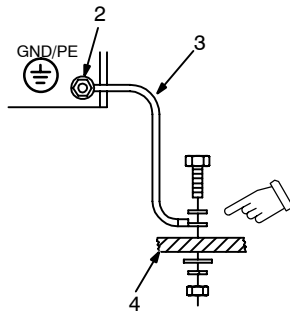

Electrically bond generator frame to vehicle frame by metal-to-metal contact.

- ▲ Bed liners, shipping skids, and some running gears insulate the welding generator from the vehicle frame. Always connect a ground wire from the generator equipment grounding terminal to bare metal on the vehicle frame as shown.

Airflow Clearance

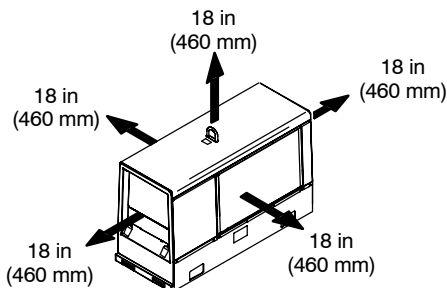

5-2. Engine Prestart Checks (Robin EH64-Powered Units)

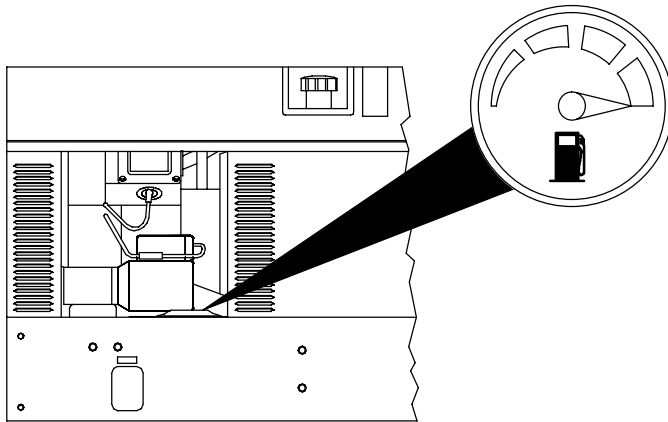
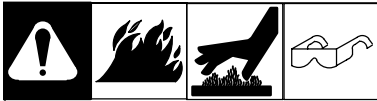

Check all fluids daily. Engine must be cold and on a level surface. Unit is shipped with 10W30 engine oil.

☞ Follow run-in procedure in engine manual.

☞ This unit has a low oil pressure shutdown switch. However, some conditions may cause engine damage before the engine shuts down. Check oil level often and do not use the oil pressure shutdown system to monitor oil level.

Fuel

Add fresh fuel before starting engine the first time (see maintenance label for specifications). Always leave filler neck empty to allow room for expansion. Check fuel level on a cold engine before use each day.

Oil

After fueling, check oil with unit on level surface. If oil is not up to full mark on dipstick, add oil (see maintenance label).

☞ To improve cold weather starting:

Keep battery in good condition. Store battery in warm area.

Use correct grade oil for cold weather.

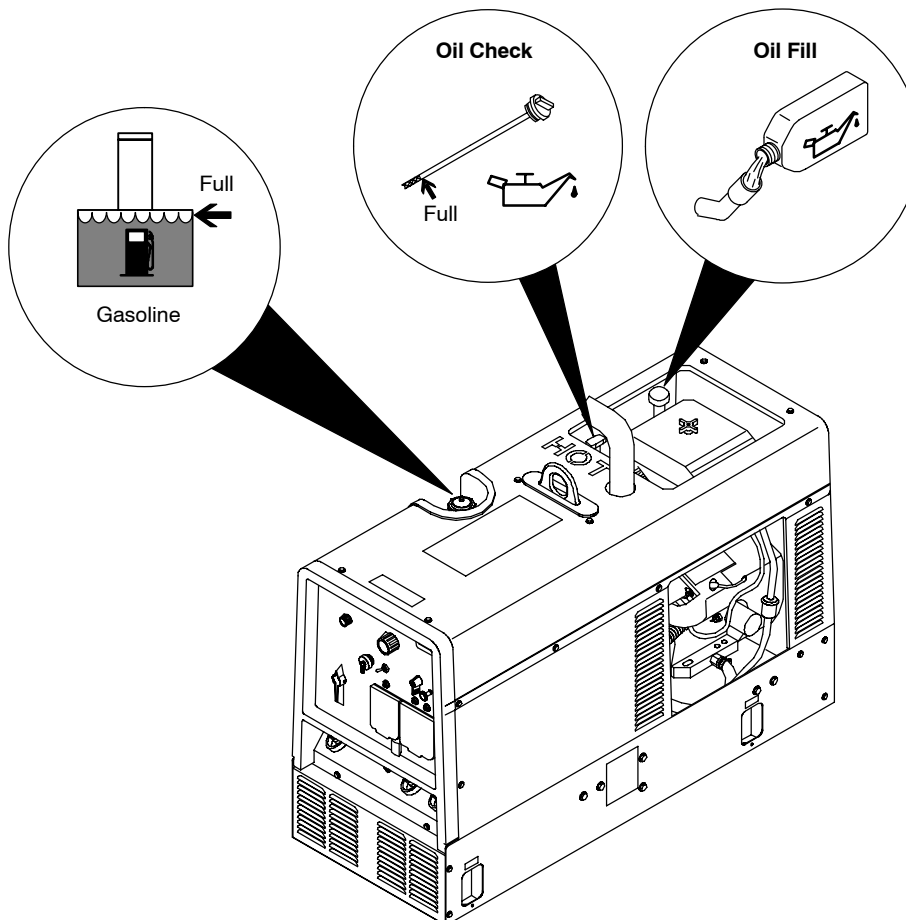

5-3. Engine Prestart Checks (Kohler-Powered Units)

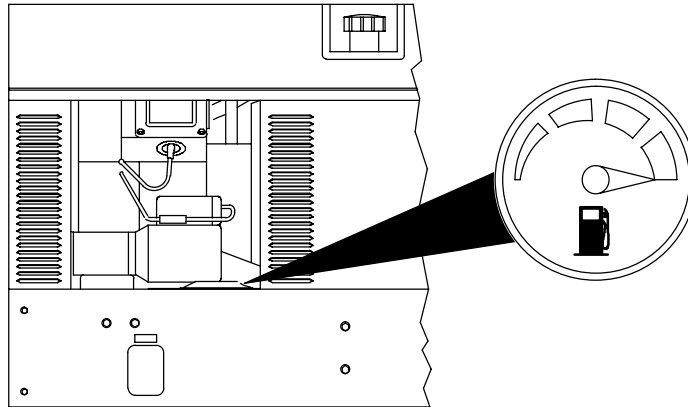
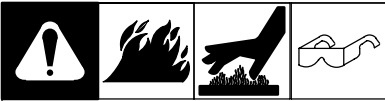

Check all fluids daily. Engine must be cold and on a level surface. Unit is shipped with 10W30 engine oil.

 Follow run-in procedure in engine manual.

 This unit has a low oil pressure shutdown switch. However, some conditions may cause engine damage before the engine shuts down. Check oil level often and do not use the oil pressure shutdown system to monitor oil level.

Fuel

Add fresh fuel before starting engine the first time (see maintenance label for specifications). Always leave filler neck empty to allow room for expansion. Check fuel level on a cold engine before use each day.

Oil

Check oil with unit on level surface. If oil is not up to full mark on dipstick, add oil (see maintenance label).

 To improve cold weather starting:

Keep battery in good condition. Store battery in warm area.

Use correct grade oil for cold weather.

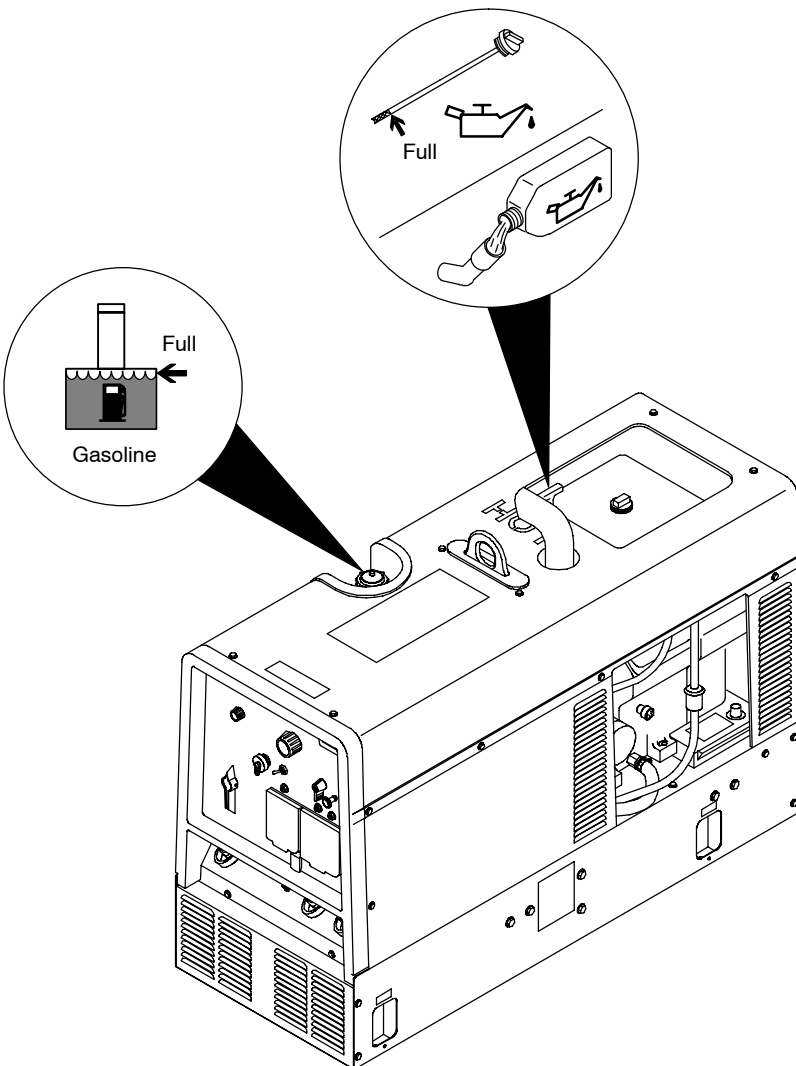

5-4. Activating The Dry Charge Battery (If Applicable)

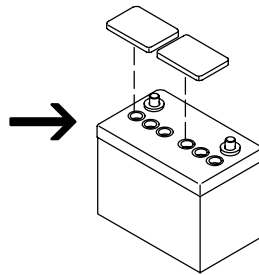
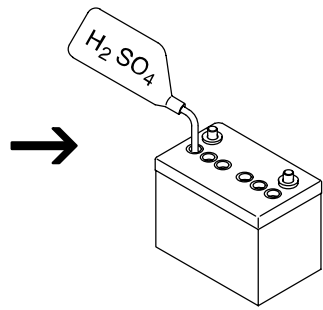
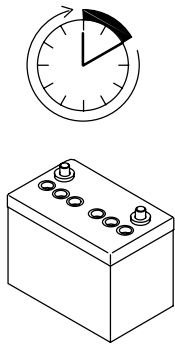
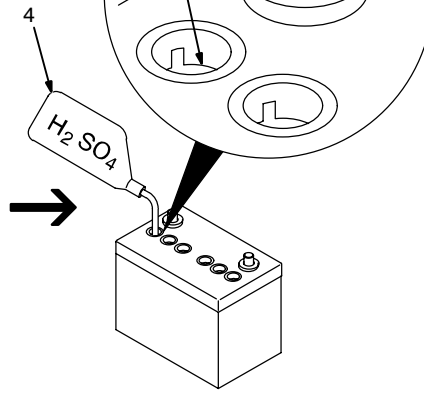
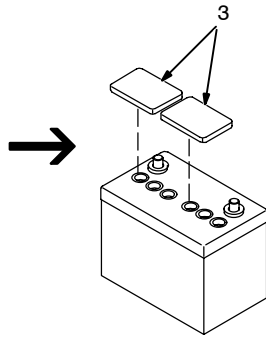
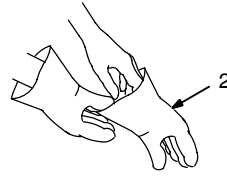
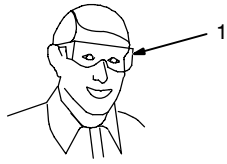
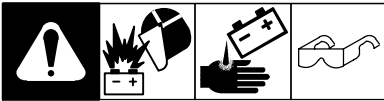

5 A For 30 Minutes

OR



30 A For 12 Minutes

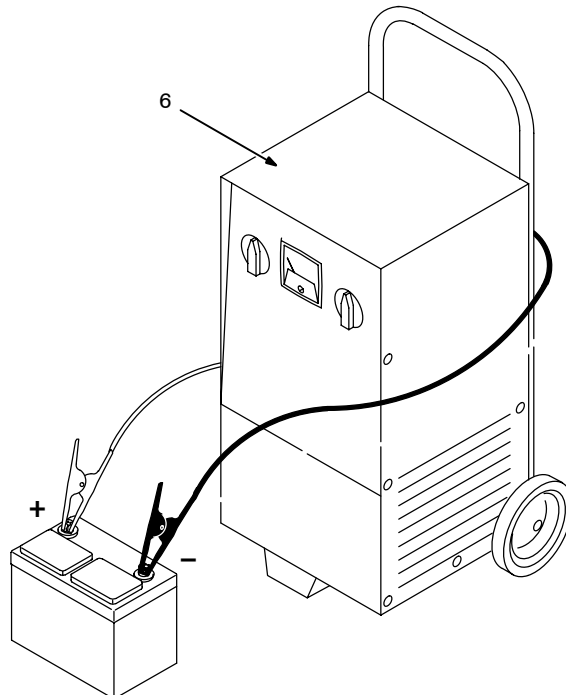

Remove battery from unit.

- 1 Eye Protection – Safety Glasses Or Face Shield
- 2 Rubber Gloves
- 3 Vent Caps
- 4 Sulfuric Acid Electrolyte (1.265 Specific Gravity)
- 5 Well

Fill each cell with electrolyte to **bottom** of well (maximum).

▲ **Do not overfill battery cells.**

Wait ten minutes and check electrolyte level. If necessary, add electrolyte to raise to proper level. Reinstall vent caps.

- 6 Battery Charger

▲ **Read and follow all instructions supplied with battery charger.**

Charge battery for 12 minutes at 30 amperes or 30 minutes at 5 amperes. Disconnect charging cables and install battery.

☞ *When electrolyte is low, add only distilled water to cells to maintain proper level.*

Tools Needed:

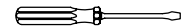

rubbergloves

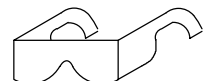

glasses

drybatt1 1/98 – S-0886

5-5. Connecting The Battery

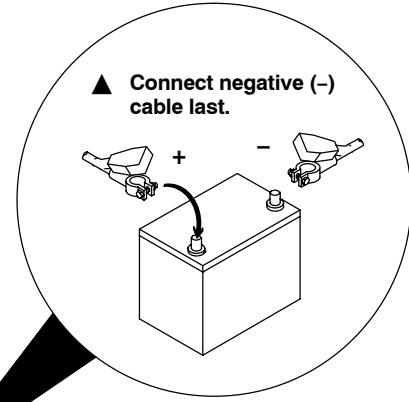
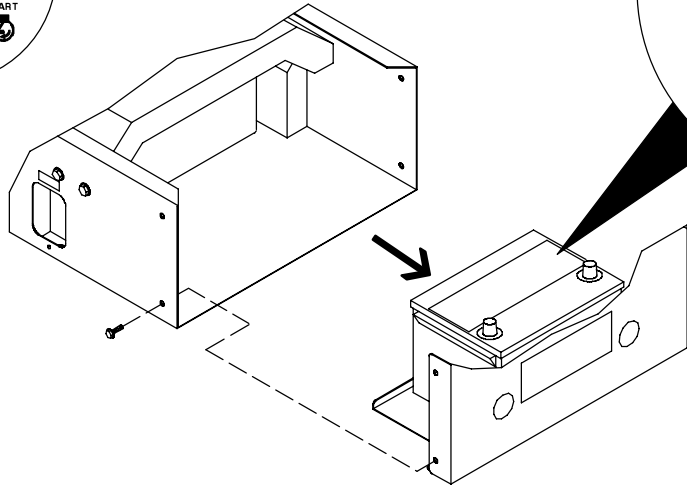
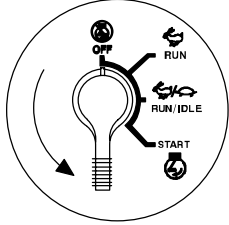

Tools Needed:



Ref. 800 394-C / Ref. 206 422 / Ref. S-0756-D

5-6. Installing Exhaust Pipe

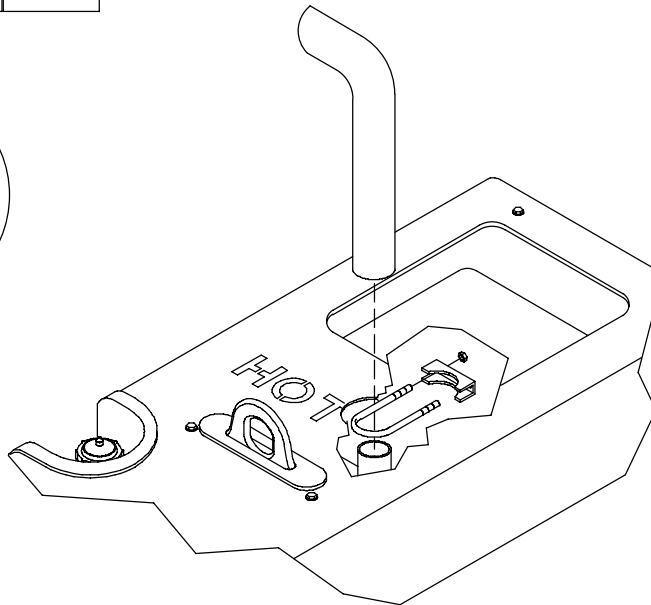
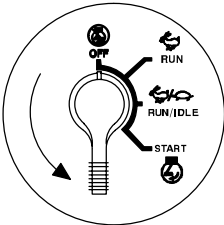
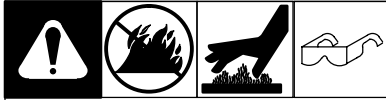

- ▲ Stop engine and let cool.
- ▲ Engine backfire can cause severe burns or other injuries. Do not point exhaust pipe toward control panel. Keep away from exhaust outlet.

☞ Point exhaust pipe in desired direction but always away from front panel and direction of travel.

Tools Needed:

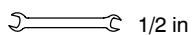

801 681 / Ref. 206 422

5-7. Connecting To Weld Output Terminals

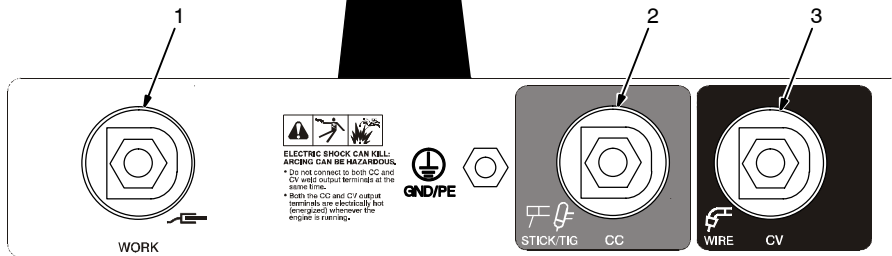
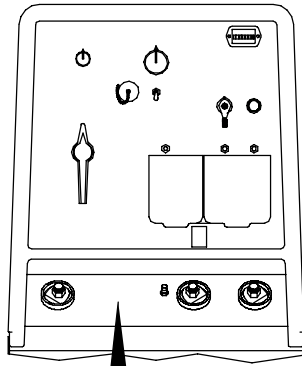
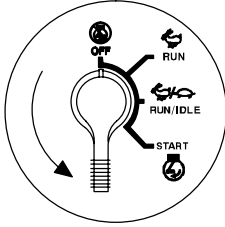

Weld output terminals on units with AC/DC output.

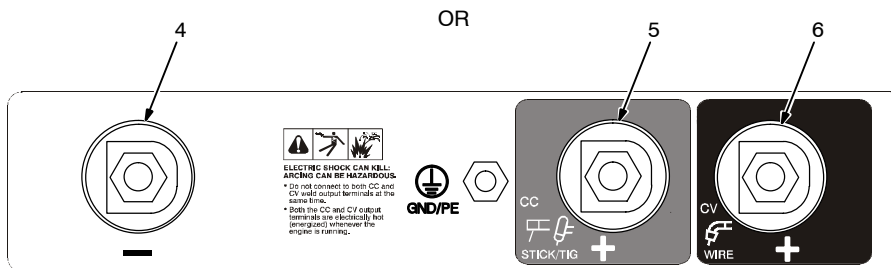

Weld output terminals on units with DC output only.

- ▲ Stop engine.
- ▲ Do not connect to CC and CV terminals at the same time.

AC/DC Models:

- 1 Work Weld Output Terminal
- 2 Stick/TIG (CC) Weld Output Terminal
- 3 Wire /CV Weld Output Terminal

For MIG welding, connect work cable to Work terminal and wire feeder cable to Wire (CV) terminal.

For Stick/TIG welding, connect work cable to Work terminal and electrode holder cable to Stick/TIG (CC) terminal.

DC Only Models:

- 4 Negative (-) Weld Output Terminal
- 5 Stick/TIG (+) Weld Output Terminal
- 6 Wire (+) Weld Output Terminal

For MIG welding, connect work cable to Negative (-) terminal and wire feeder cable to CV (Wire) terminal.

For Stick welding, connect work cable to Negative (-) terminal and electrode holder cable to CC (Stick/TIG) terminal.

For TIG welding, connect work cable to CC (Stick/TIG) terminal and electrode holder cable to Negative (-) terminal.

802 850 / Ref. 206 422 / 204 353

5-8. Selecting Weld Cable Sizes*

|  <p>Weld Output Terminals</p> <p>▲ Stop engine before connecting to weld output terminals.</p> <p>▲ Do not use worn, damaged, undersized, or poorly spliced cables.</p> | Welding Amperes | Weld Cable Size** and Total Cable (Copper) Length in Weld Circuit Not Exceeding*** | | | | | | | |
|---|-----------------|--|----------------------|----------------------|---------------|------------------|------------------|-------------------|-------------------|
| | | 100 ft (30 m) or Less | | 150 ft (45 m) | 200 ft (60 m) | 250 ft (70 m) | 300 ft (90 m) | 350 ft (105 m) | 400 ft (120 m) |
| | | 10 – 60% Duty Cycle | 60 – 100% Duty Cycle | 10 – 100% Duty Cycle | | | | | |
| | 100 | 4 (20) | 4 (20) | 4 (20) | 3 (30) | 2 (35) | 1 (50) | 1/0 (60) | 1/0 (60) |
| | 150 | 3 (30) | 3 (30) | 2 (35) | 1 (50) | 1/0 (60) | 2/0 (70) | 3/0 (95) | 3/0 (95) |
| | 200 | 3 (30) | 2 (35) | 1 (50) | 1/0 (60) | 2/0 (70) | 3/0 (95) | 4/0 (120) | 4/0 (120) |
| | 250 | 2 (35) | 1 (50) | 1/0 (60) | 2/0 (70) | 3/0 (95) | 4/0 (120) | 2 ea. 2/0 (2x70) | 2 ea. 2/0 (2x70) |
| | 300 | 1 (50) | 1/0 (60) | 2/0 (70) | 3/0 (95) | 4/0 (120) | 2 ea. 2/0 (2x70) | 2 ea. 3/0 (2x95) | 2 ea. 3/0 (2x95) |
| | 350 | 1/0 (60) | 2/0 (70) | 3/0 (95) | 4/0 (120) | 2 ea. 2/0 (2x70) | 2 ea. 3/0 (2x95) | 2 ea. 3/0 (2x95) | 2 ea. 4/0 (2x120) |
| | 400 | 1/0 (60) | 2/0 (70) | 3/0 (95) | 4/0 (120) | 2 ea. 2/0 (2x70) | 2 ea. 3/0 (2x95) | 2 ea. 4/0 (2x120) | 2 ea. 4/0 (2x120) |

* This chart is a general guideline and may not suit all applications. If cable overheats, use next size larger cable.





**Weld cable size (AWG) is based on either a 4 volts or less drop or a current density of at least 300 circular mils per ampere.
() = mm² for metric use

***For distances longer than those shown in this guide, call a factory applications representative at 920-735-4505.

S-0007-F

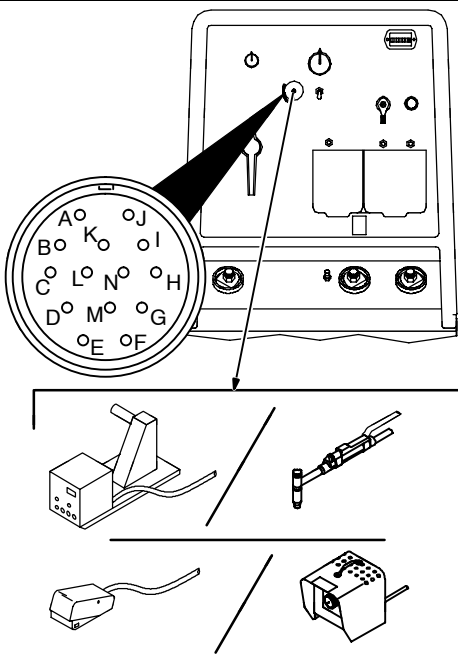
5-9. Remote Receptacle Information

| | |
|---|---|
| NOTE  | <i>Engine runs at weld/power speed whenever a device connected to the remote receptacle is running.</i> |
|---|---|

|  |  REMOTE 14 | Socket* | Socket Information |
|---|--|---|--------------------|
| | 24 VOLTS AC OUTPUT (CONTACTOR)  | A | 24 volts ac. |
| B | | Contact closure to A completes 24 volt ac contactor control circuit and keeps engine at Run speed in all modes. Protected by circuit breaker CB5. | |
| 115 VOLTS AC OUTPUT (CONTACTOR)  | I | 115 volts ac. Protected by fuse F2. | |
| | J | Contact closure to I completes 115 volts ac contactor control circuit. | |
| REMOTE OUTPUT CONTROL | C | 0 to +10 volts dc output to remote control in Stick and TIG modes. +10 volts dc output to remote control in Wire mode. | |
| | D | Remote control circuit common. | |
| | E | 0 to +10 volts dc input command signal from remote control. Voltage is dependent on front panel Voltage/Amperage control setting. | |
| GND | G | Circuit common for 24 and 115 volts ac circuits. | |
| | K | Chassis common. | |

*The remaining sockets are not used.

5-10. Adjusting Wire (MIG) Weld Puddle Consistency

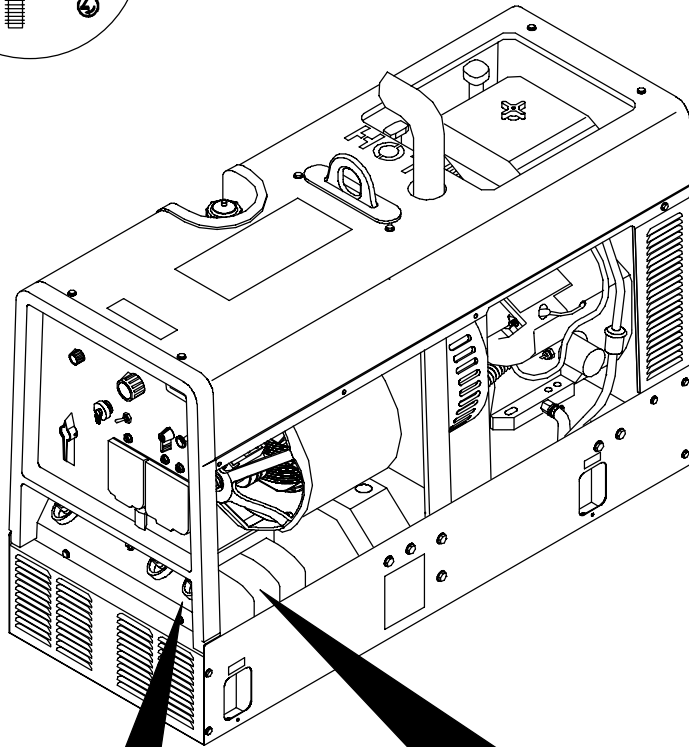
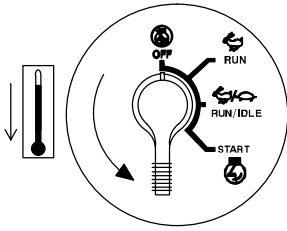

▲ Stop engine and let cool.

Stabilizer DC-Z is factory connected to suit most Wire (MIG) welding applications.

To change Wire (MIG) weld puddle consistency, proceed as follows:

Remove cover and right side panel.

- 1 Stabilizer DC-Z
- 2 Wire /CV Weld Output Terminal
- 3 Stabilizer Leads 29, 28, And 27

Lead 29 – provides stiffest weld puddle

Lead 28 – provides wetter weld puddle (for mild steel)

Lead 27 – provides wettest weld puddle (for stainless steel)

Lead 29 is connected to the Wire/CV weld output terminal at the factory.

Disconnect lead 29 from the Wire/CV weld output terminal.

For wetter weld puddle (for mild steel):

Remove insulated sleeving from lead 28. Connect lead 28 to Wire/CV weld output terminal, reusing hardware. Insulate lead 29 with sleeving removed from lead 28. Secure sleeving with cable ties.

For wettest weld puddle (for stainless steel):

Remove insulated sleeving from lead 27. Connect lead 27 to Wire/CV weld output terminal, reusing hardware. Insulate lead 29 with sleeving removed from lead 27. Secure sleeving with cable ties.

Reinstall side panel.

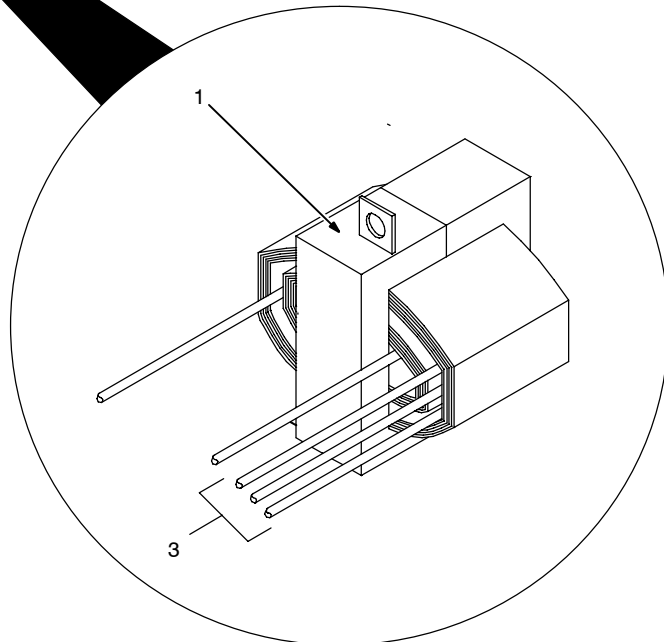
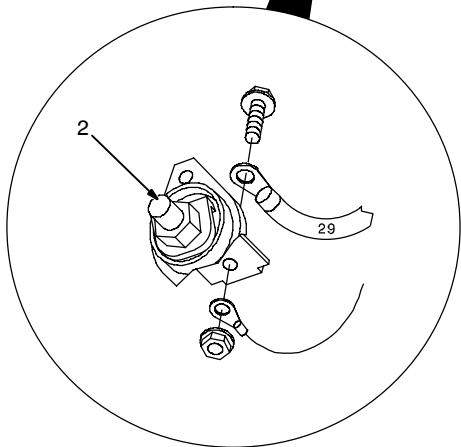

Tools Needed:



3/8, 7/16 in

SECTION 6 – OPERATING WELDING GENERATOR

6-1. Front Panel Controls

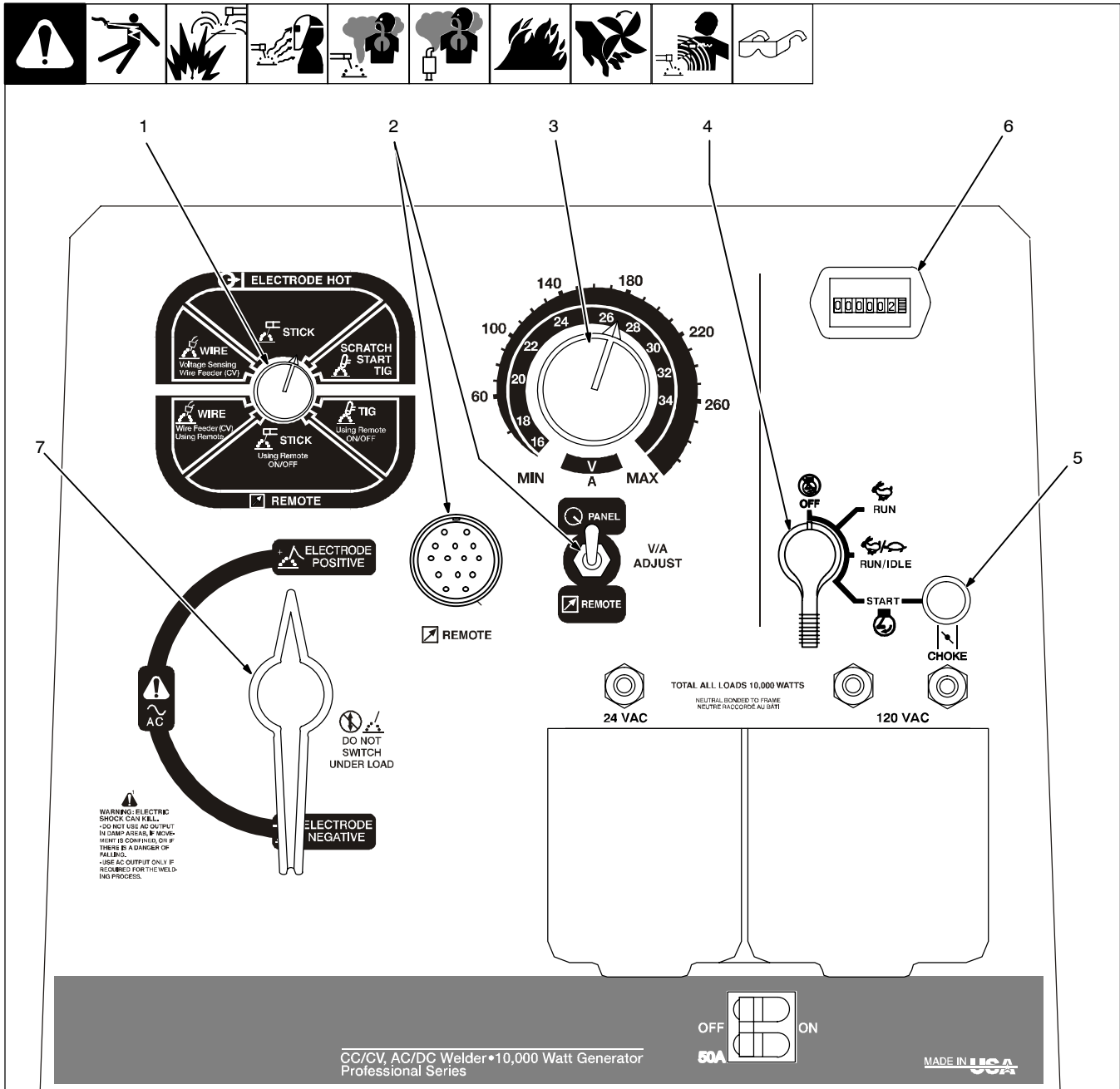

1 Process/Contactor Switch

See Section 6-2 for Process/Contactor switch information.

2 Voltage/Amperage Adjust Switch And Remote Receptacle

Use switch to select front panel or remote voltage/amperage control. For remote control, place switch in Remote position and connect remote control to Remote receptacle RC4 (see Sections 5-9 and 6-3).

3 A/V Control

Use control to select weld voltage or amperage. Control may be adjusted while welding.

With Process/Contactor switch in any Stick or TIG setting, use control to adjust amperage. With Process/Contactor switch in any Wire position, use control to adjust voltage.

With V/A Adjust Switch in Remote position, control limits the remote amperage in Stick and TIG modes, but has no effect in MIG modes.

4 Engine Control Switch

Use switch to start engine, select speed, and stop engine. In Run/Idle position, engine runs at idle speed at no load, and weld/power speed under load. In Run position, engine runs at weld/power speed.

☞ Place switch in Run position for TIG (GTAW) welding using a high frequency device.

☞ The unit will not return to idle speed when the remote contactor is on.

5 Engine Choke Control

Use control to change engine air-fuel mix when starting engine.

To Start: pull out choke and turn Engine Control switch to Start position. Release switch and slowly push choke in when engine starts.

☞ If the engine does not start, let the engine come to a complete stop before attempting restart.

To Stop: turn Engine Control switch to Off position.

6 Engine Hour Meter

7 DC Polarity/AC Switch (AC/DC Models Only)

▲ **Do not switch under load.**

Use switch to select AC weld output or polarity of DC weld output.

Ref. 206 422

6-2. Process/Contactor Switch On CC/CV Models

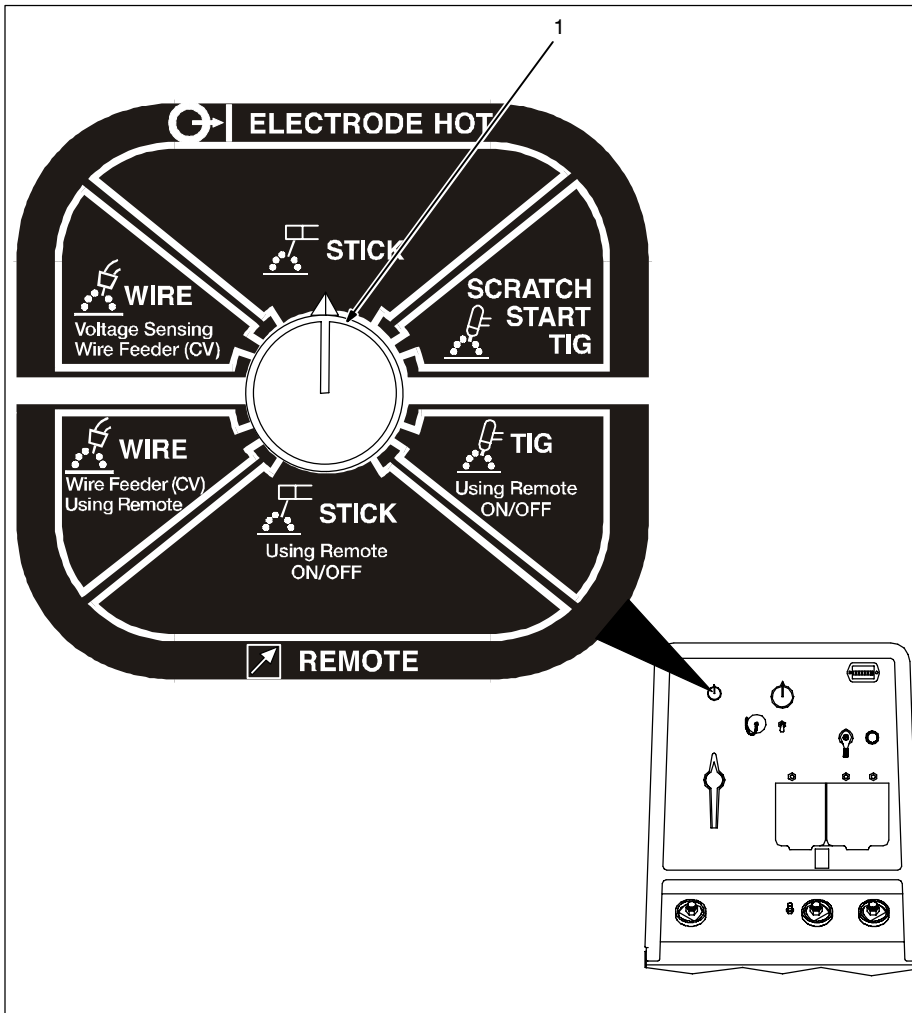

1 Process/Contactor Switch

▲ **Weld output terminals are energized when Process/Contactor switch is in an Electrode Hot position and the engine is running.**

☞ *The unit will not return to idle speed when Process/Contactor switch is in a Wire or TIG mode and the remote contactor is on (closure between pins A and B on remote receptacle).*

Use switch to select weld process and weld output on/off control (see table below and Section 5-9).

Place switch in Remote positions to turn weld output on and off with a device connected to the remote receptacle.

Place switch in Electrode Hot positions for weld output to be on whenever the engine is running.

Use Stick positions for air carbon arc (CAC-A) cutting and gouging.

When switch is in a Stick position, the dig circuit provides additional amperage during low voltage (short arc length conditions) to prevent "sticking" electrodes.

The dig circuit is disabled when switch is in Wire or TIG positions.

802 850

Process/Contactor Switch Settings

| Switch Setting | Process | Output On/Off Control |
|-----------------------------------|---|-----------------------|
| Remote - TIG | GTAW With HF Unit, Pulsing Device, Or Remote Control | At Remote Receptacle |
| Remote - Stick | Stick (SMAW) With Remote On/Off | At Remote Receptacle |
| Remote - Wire | MIG (GMAW) | At Remote Receptacle |
| Electrode Hot - Wire | MIG (GMAW) | Electrode Hot |
| Electrode Hot - Stick | Stick (SMAW), Air Carbon Arc (CAC-A) Cutting And Gouging | Electrode Hot |
| Electrode Hot - Scratch Start TIG | Scratch Start TIG (GTAW) | Electrode Hot |

6-3. Remote Amperage/Voltage Control

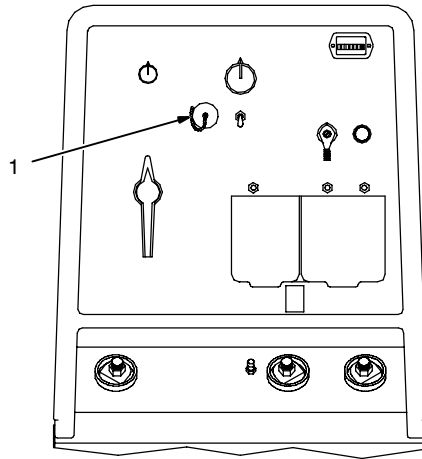

- 1 Remote Receptacle RC4
Connect optional remote control to RC4 (see Section 5-9).
- 2 Remote Hand Control (Optional)
- 3 Remote Foot Control (Optional)

 Engine runs at weld/power speed in Wire and TIG modes whenever a device connected to the remote receptacle makes closure between pins A and B (example: trigger pull on MIG gun).

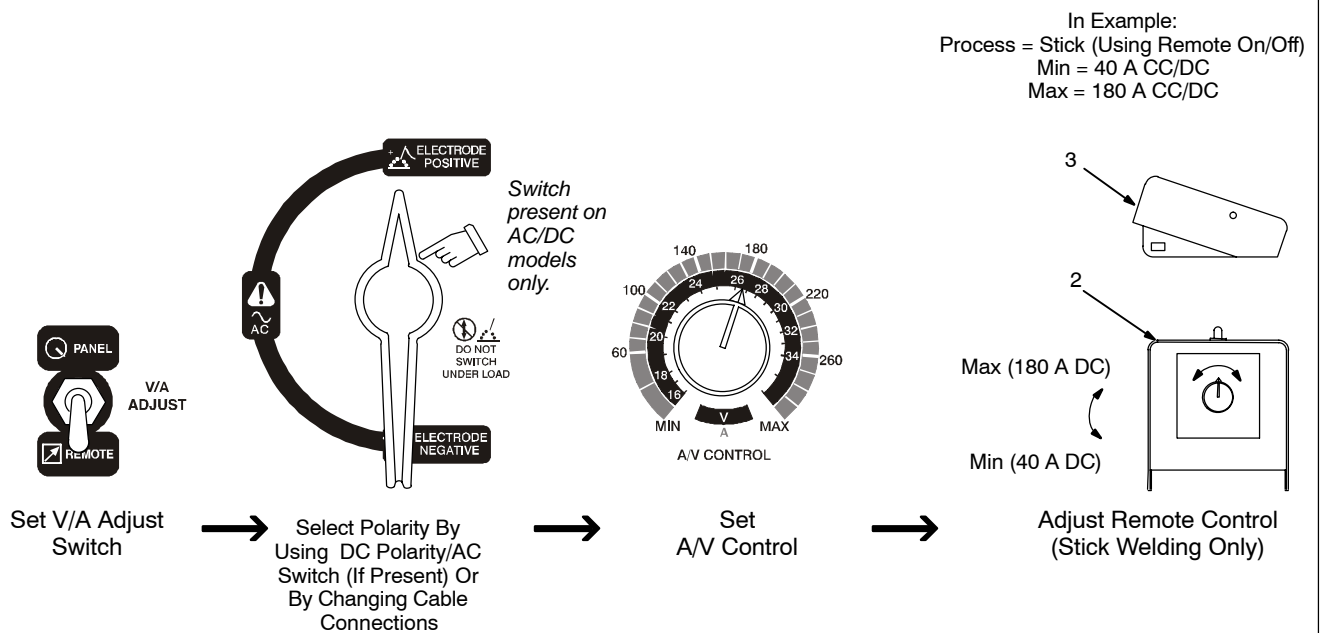

802 850 / 206 422 / S-0769 / S-0774

SECTION 7 – OPERATING AUXILIARY EQUIPMENT

7-1. Generator Power Receptacles And Circuit Breakers

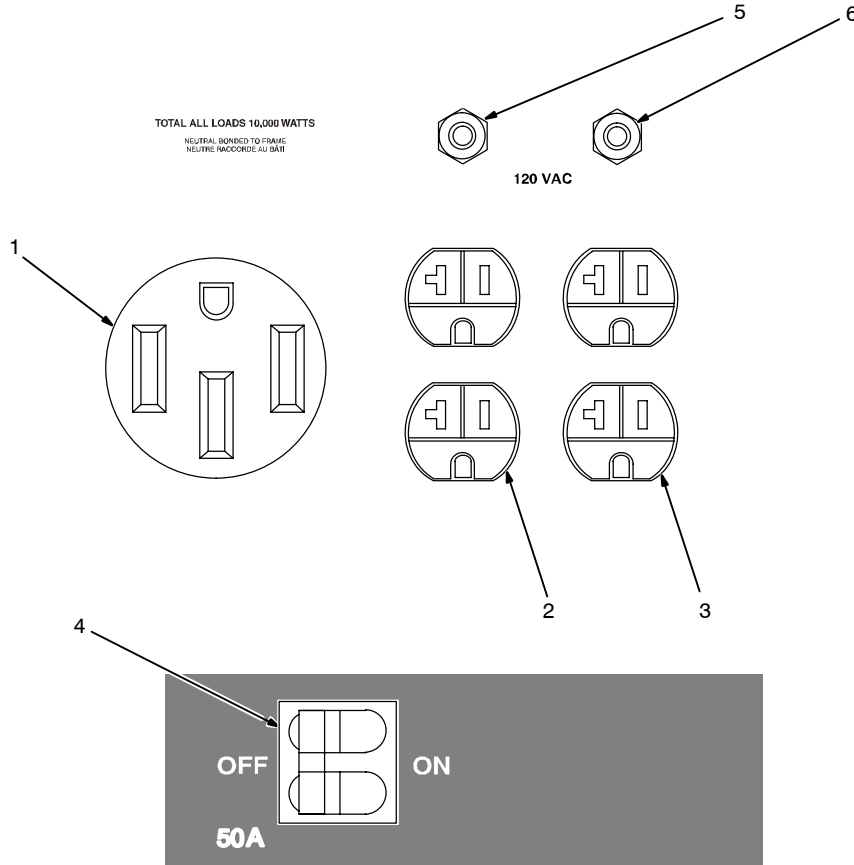

▲ If unit does not have GFCI receptacles, use GFCI-protected extension cord.

☞ Generator power decreases as weld current increases.

1 240 V 50 A AC Receptacle RC1

RC1 supplies 60 Hz single-phase power at weld/power speed. Maximum output is 9.5 kVA/kW.

2 120 V 20 A AC Duplex Receptacle RC2

3 120 V 20 A AC Duplex Receptacle RC3

RC2 and RC3 supply 60 Hz single-phase power at weld/power speed. Maximum output from RC2 or RC3 is 2.4 kVA/kW.

4 Circuit Breaker CB1

CB1 protects receptacles RC1, RC2, RC3, and 115 volt ac output to Remote Receptacle RC4 from overload. If CB1 opens, the receptacles do not work and 115 volt ac output to Remote Receptacle RC4 stops. Place switch in On position to reset breaker.

5 Circuit Breaker CB3

6 Circuit Breaker CB4

CB3 protects RC2 and CB4 protects RC3 from overload. If a circuit breaker opens, the receptacle does not work. Press button to reset breaker.

☞ If circuit breaker continues to open, contact Factory Authorized Service Agent.

Combined output of all receptacles limited to 10 kVA/kW rating of the generator.

EXAMPLE: If 20 A is drawn from each 120 V duplex receptacle, only 20 A is available at the 240 V receptacle:

$$2 \times (120 \text{ V} \times 20 \text{ A}) + (240 \text{ V} \times 20 \text{ A}) = 9.6 \text{ kVA/kW}$$

7-2. Optional Generator Power Receptacles

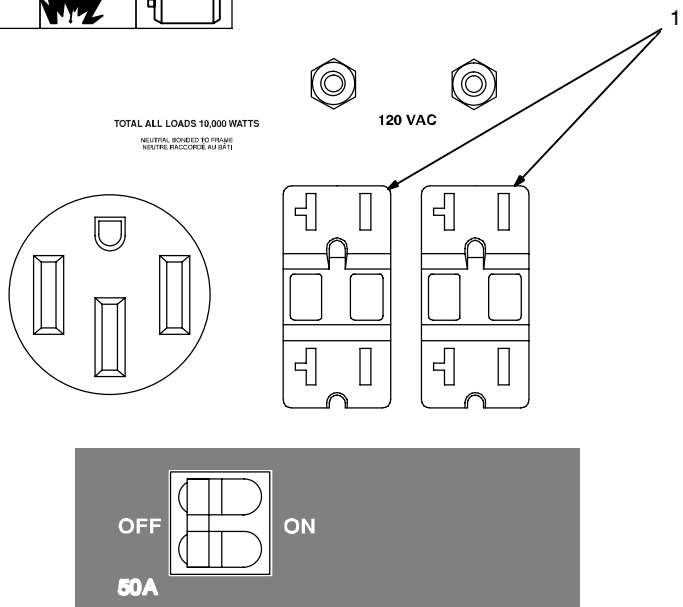

▲ If unit does not have GFCI receptacles, use GFCI-protected extension cord.

☞ Generator power decreases as weld current increases.

Combined output of all receptacles limited to 8 kVA/kW rating of the generator.

GFCI Receptacle Option

1 120 V 20 A AC GFCI Receptacles GFCI-2 and GFCI-3

GFCI-2 and GFCI-3 supply 60 Hz single-phase power at weld/power speed. Maximum output from GFCI-2 or GFCI-3 is 2.4 kVA/kW. Circuit breaker protection is the same as standard receptacles.

If a ground fault is detected, the GFCI Reset button pops out and the circuit opens to disconnect the faulty equipment. Check for damaged tools, cords, plugs, etc. connected to the receptacle. Press button to reset receptacle and resume operation.

☞ At least once a month, run engine at weld/power speed and press Test button to verify GFCI is working properly.

Ref. 206 422

Notes

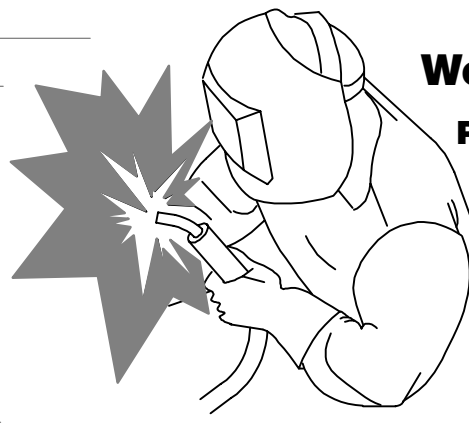

Work like a Pro!

Pros weld and cut safely. Read the safety rules at the beginning of this manual.

7-3. Wiring Instructions For Optional 240 Volt, Single-Phase Plug (NEMA 14-50P)



| Current Available in Amperes | |
|------------------------------|------------------------------|
| 240 V Receptacle* | Each 120 V Duplex Receptacle |
| 0 | 20 |
| 5 | 20 |
| 10 | 20 |
| 15 | 20 |
| 20 | 20 |
| 25 | 15 |
| 30 | 10 |
| 35 | 5 |
| 40 | 0 |

V x A = Watts

*One 240 V load or two 120 V loads.

The plug can be wired for a 240 V, 2-wire load or a 120/240V, 3-wire load. See circuit diagram.

1 Plug Wired for 120/240 V, 3-Wire Load

When wired for 120 V loads, each duplex receptacle shares a load with one half of 240 V receptacle.

2 Plug Wired for 240 V, 2-Wire Load

3 Neutral (Silver) Terminal

4 Load 1 (Brass) Terminal

5 Load 2 (Brass) Terminal

6 Ground (Green) Terminal

7 Amperes Available using 120/240 V Plug

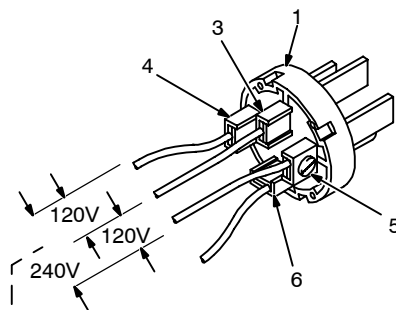

Tools Needed:

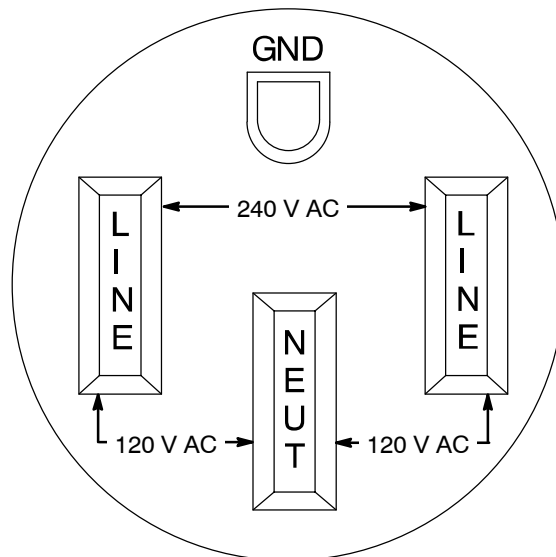
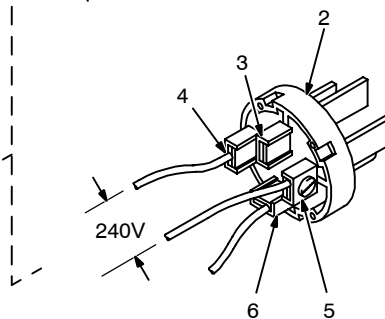
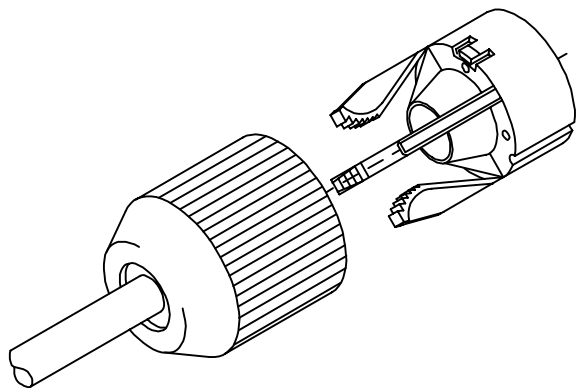
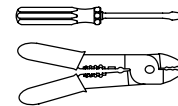

SECTION 8 – MAINTENANCE (Robin EH64-POWERED UNITS)

8-1. Maintenance Label (Robin EH64-Powered Units)

KOHLER CH20, ROBIN EH64/EH65 GAS ENGINES



See Engine Manual for complete engine care. Give Engine Specification and Serial Number when ordering parts.

 **Check Daily.**

Recommended Oil
API Service Classification . . . SG or higher
(If using LP fuel, use synthetic oil.)

Oil Change 100 hours
Oil Filter Change 200 hours
Oil Filter **KOHLER:** MILLER 066 698, Kohler 1205001
ROBIN: MILLER 198 754, Robin 248-65801-00

Oil Capacity w/filter change . Approximately 1.5 quarts

DO NOT OVERFILL . . **KOHLER:** Keep oil level between L & F marks on dipstick.
ROBIN: Keep oil level between 2 holes on dipstick.

To Drain Oil:
Push And Turn CCW



Pull

| | °C | °F | | | |
|--|-----|------|---|--------------|---|
| | +38 | +100 | ↑ | 10W-30 | ↑ |
| | +27 | +80 | | | |
| | +10 | +50 | ↓ | 5W-20, 5W-30 | ↓ |
| | 0 | +32 | | | |
| | -18 | 0 | | | |
| | -29 | -20 | | | |

Gasoline

Fuel Grade Unleaded, 87 Octane min.
Fuel Filter **KOHLER:** MILLER 215 984, Kohler 2505008
ROBIN: MILLER 215 984, Robin 263-65012-A3



Air Filter Service 100 hours – see Owner's Manual
Air Filter **KOHLER:** MILLER 067 272, Kohler 4708303
Air Filter Wrapper **KOHLER:** MILLER 067 273, Kohler 2408302
Air Filter **ROBIN:** MILLER 198 755, Robin 263-32610-A1
(Includes Air Filter Wrapper)



12 Volt Battery BCI Group 58
Cranking Performance at 0°F (-18°C) . . . 430 Amps min.



Engine Speed
No Load
High Speed . . . 3675-3750 RPM
Idle 2200-2300 RPM
Miller Legend. . See Owner's Manual

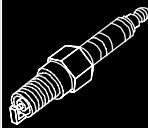

Spark Plug **KOHLER:** MILLER 067 007, Kohler 1213202,
Champion RC-12YC
Gap: 0.030 in.
ROBIN: MILLER 198 777, Robin X65-01407-30,
NGK BPR4EY
Use only resistor spark plugs and wires.



















Tune-up and Filter Kit . . (Includes Air, Oil and Fuel Filters, and 2 Spark Plugs)
KOHLER: MILLER 180 096
ROBIN: MILLER 199 062

215 939-C

OM-4407 Page 29

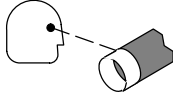
8-2. Routine Maintenance (Robin EH64-Powered Units)

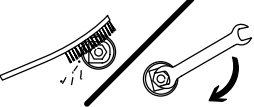
Note  Follow the storage procedure in the engine owner's manual if the unit will not be used for an extended period.

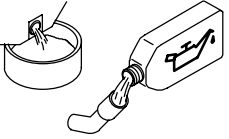
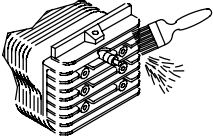
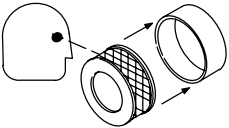
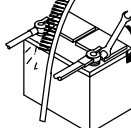
| | | | |
|---|---|---|--|
|        | |  <p>Recycle engine fluids.</p> | <p>▲ Stop engine before maintaining.</p> <p> See also Engine Manual and Maintenance Label for important start-up, service, and storage information. Service engine more often if used in severe conditions.</p> <p>* To be done by Factory Authorized Service Agent.</p> |
|  Every 8 h | | | |
| <p>Check fluid levels. See Section 5-2.</p> |   | <p>Wipe up spills.</p> |  |
|  Every 20 h | |  Every 25 h | |
| <p>Check and clean spark arrestor screen. See Section 8-4.</p> |  | <p>Service air cleaner wrapper (foam element). See Section 8-3.</p> |  |
|  Every 50 h | | | |
| <p>Clean and tighten weld terminals.</p> | |  | |
|  Every 100 h | | | |
| <p>Change oil. See Section 8-6 and maintenance label.</p> |  | <p>Clean cooling system. See Engine Manual.</p> |  |
| <p>Service air cleaner element. See Section 8-3.</p> |  | <p>Clean and tighten battery connections.</p> |  |

 **Every 200 h**

Change oil filter. See Section 8-6 and maintenance label.

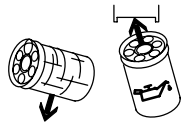

Replace fuel filter. See Section 8-6.

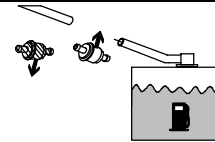

Check spark plugs.

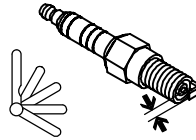

Replace unreadable labels.

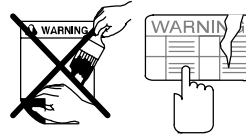

 **Every 500 h**

Repair or replace cracked cables.

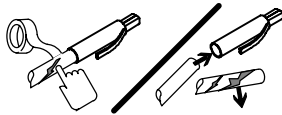

Service welding generator brushes and slip rings. Service more often in dirty conditions.*

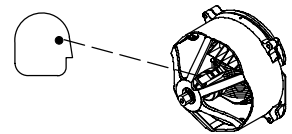

Check valve clearance.*

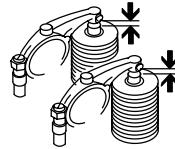

 **Every 1000 h**

Blow out or vacuum inside. During heavy service, clean monthly.

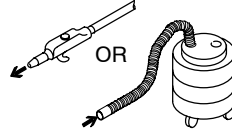

8-3. Servicing Air Cleaner (Robin EH64-Powered Units)

▲ Stop engine.
▲ Do not run engine without air cleaner or with dirty element.

1 Wrapper (Foam Element)
 2 Element

Wash wrapper with soap and water solution. Allow wrapper to air dry completely.

Replace element if dirty, oily, or damaged.

aircleaner5 1/97 – 803 070 / Ref. 200 017 / S-0759

8-4. Servicing Optional Spark Arrestor (Robin EH64-Powered Units)

▲ Stop engine and let cool.

1 Spark Arrestor Screen

Clean and inspect screen. Replace spark arrestor if screen wires are broken or missing.

Tools Needed:
 1/4 in Wrench
 Wire Brush

Ref. 803 098 / Ref. 183 175-A

8-5. Overload Protection (Robin EH64-Powered Units)

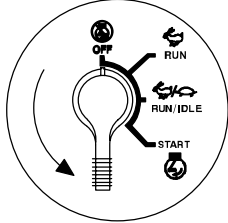

Tools Needed:

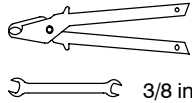

▲ Stop engine.

☞ *When a circuit breaker or fuse opens, it usually indicates a more serious problem exists. Contact a Factory Authorized Service Agent.*

1 Circuit Breaker CB5

CB5 protects the 24 volt ac output to Remote receptacle RC4. If CB5 opens, 24 volt ac output to RC4 stops.

Press button to reset breaker.

2 Fuse F2 (See Parts List)

F2 is located behind the front panel. F2 protects the 115 volt output to Remote Receptacle RC4. If F2 opens, 115 volt ac output to RC4 stops.

F6 protects the engine wiring system from overload. If F6 opens, engine will not crank.

4 Fuse F1 (See Parts List)

Remove side panel.

F1 protects the exciter excitation winding from overload. If F1 opens, weld and generator power output stops.

Replace any open fuses. Reinstall cover before operating unit.

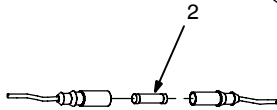

Located behind front panel.

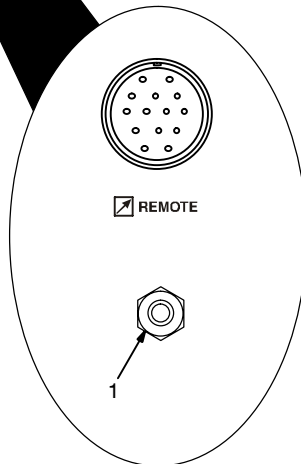
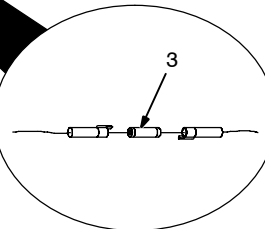
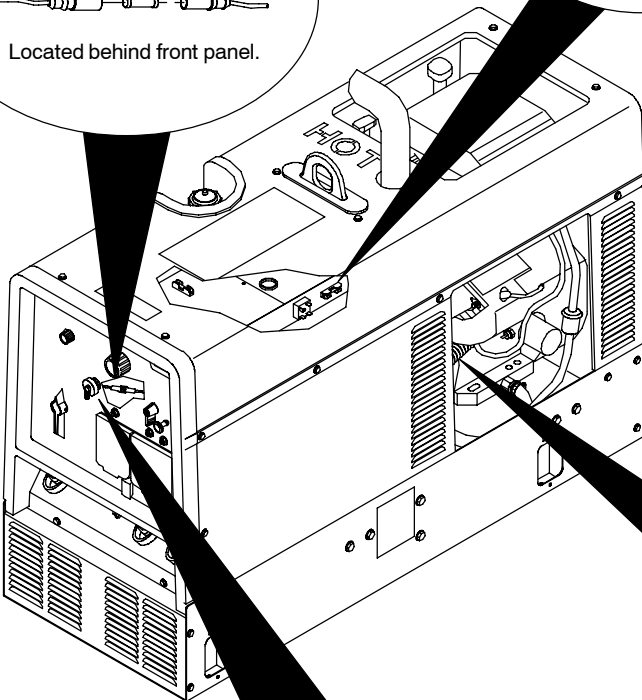
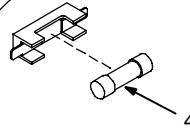

8-6. Changing Engine Oil, Oil Filter, and Fuel Filter (Robin EH64-Powered Units)

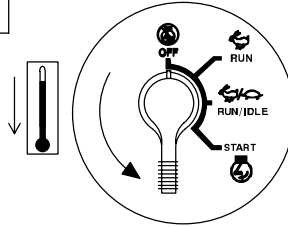

▲ **Stop engine and let cool.**

- 1 Oil Drain Valve
- 2 Oil Filter

Change engine oil and filter according to engine owner's manual.

▲ **Close valve and valve cap before adding oil and running engine.**

Fill crankcase with new oil to full mark on dipstick (see Section 8-1).

- 3 Fuel Filter
- 4 Fuel Line

Replace line if cracked or worn. Install new filter. Wipe up any spilled fuel.

Start engine, and check for fuel leaks.

▲ **Stop engine, tighten connections as necessary, and wipe up fuel.**

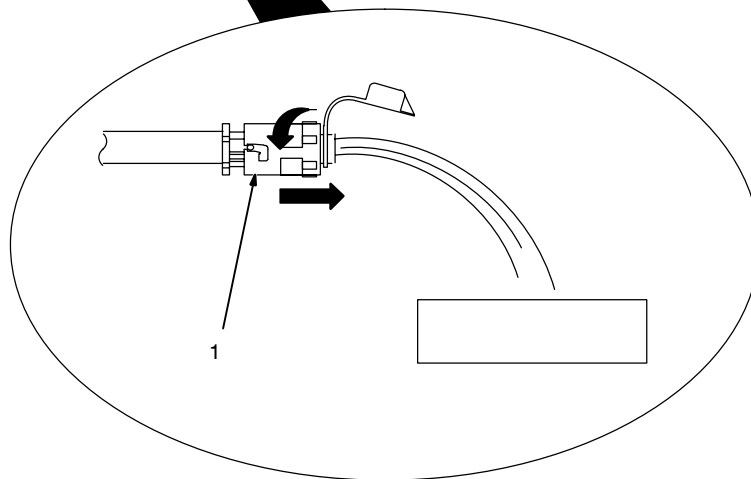
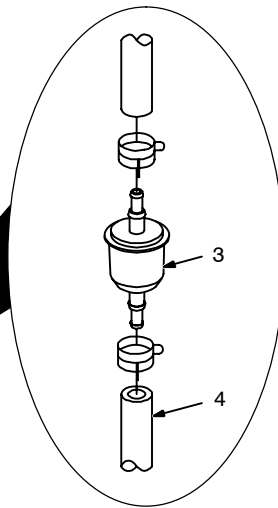
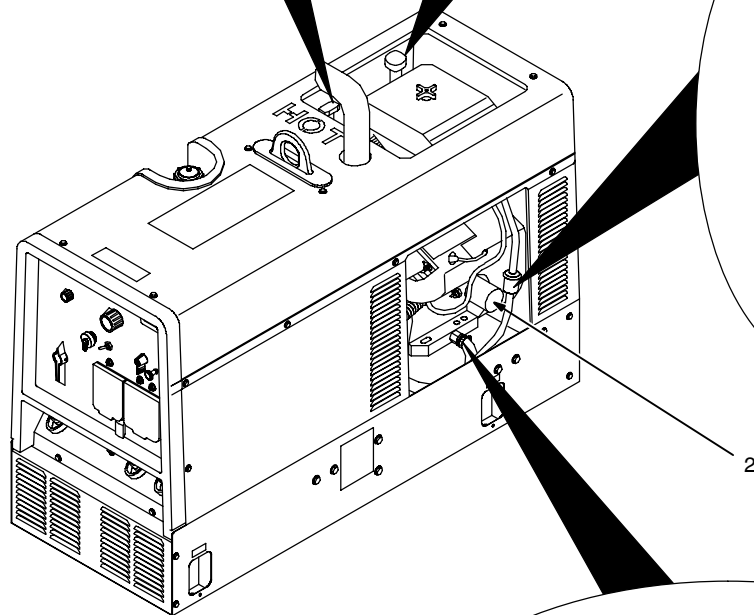
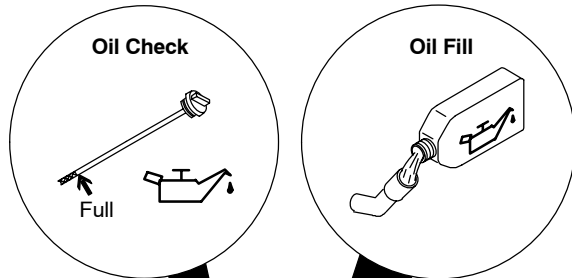

Tools Needed:

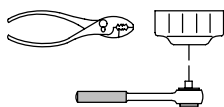

8-7. Adjusting Engine Speed (Robin EH64-Powered Units)



| | |
|--|----------------|
| | |
| | 2200 ± 100 rpm |
| | 3700 ± 50 rpm |

After tuning engine, check engine speeds with a tachometer (see table). If necessary, adjust speeds as follows:

Start engine and run until warm.

Remove wrapper to access speed adjustments.

Idle Speed Adjustment

Move Engine Control switch to Run/Idle position.

- 1 Throttle Solenoid
- 2 Mounting Screws
- 3 Idle Speed Screw

Loosen mounting screws. Adjust solenoid position so engine runs at idle speed. If necessary, back out idle speed screw so solenoid can be moved to correct position. Tighten mounting screws. Be sure solenoid linkage works smoothly.

Turn idle speed screw for fine adjustments.

Weld/Power Speed Adjustment

Move Engine Control switch to Run position.

- 4 Jam Nut
- 5 Lock Nut
- 6 Weld/Power Speed Adjustment Screw

Loosen jam nut and lock nut. Turn adjustment screw until engine runs at weld/power speed. Tighten jam nut, and then tighten lock nut.

▲ Stop engine.

Reinstall wrapper.

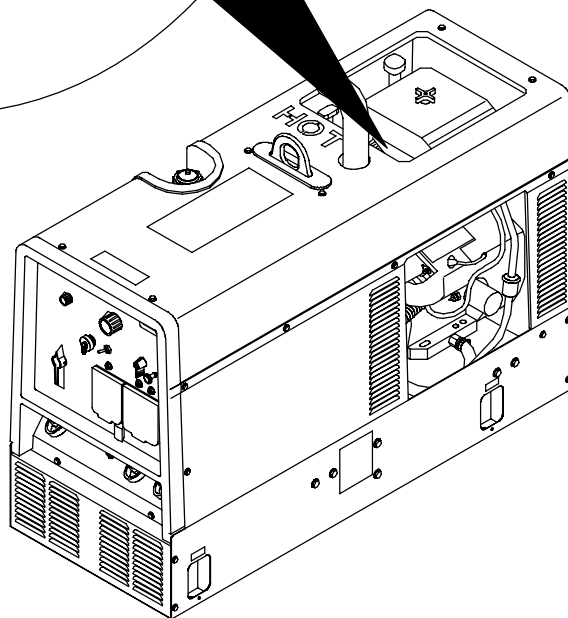
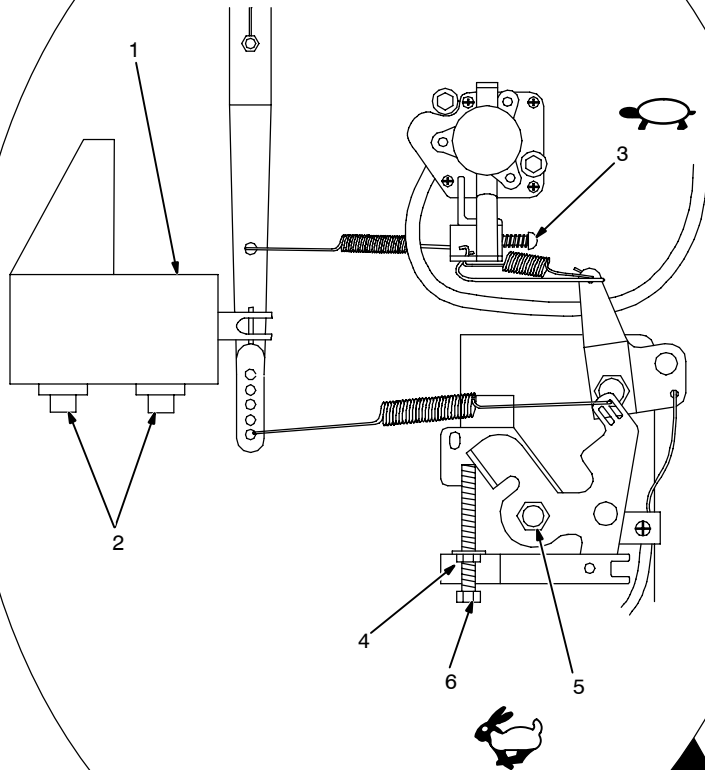



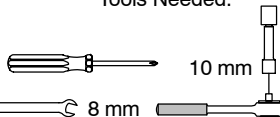

Tools Needed:

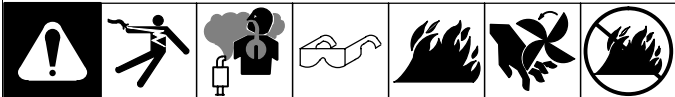

803 098

SECTION 9 – MAINTENANCE (KOHLER-POWERED UNITS)

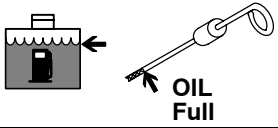
9-1. Routine Maintenance (Kohler-Powered Units)

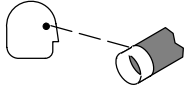
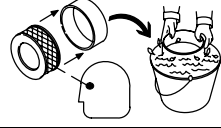
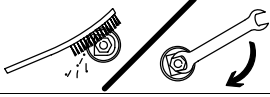
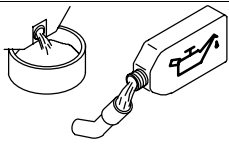
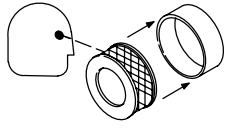
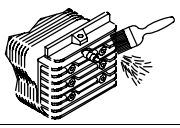
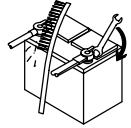
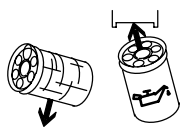
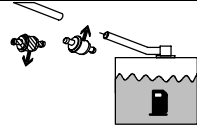
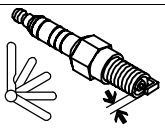
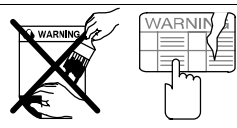
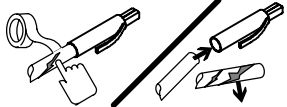
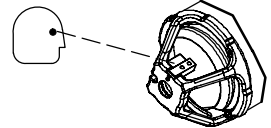
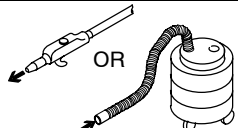
| | | | |
|---|---|---|---|
|  | |  <p>Recycle engine fluids.</p> | <p>▲ Stop engine before maintaining.</p> <p>☞ See also <i>Engine Manual and Maintenance Label</i> for important start-up, service, and storage information. Service engine more often if used in severe conditions.</p> <p>* To be done by Factory Authorized Service Agent.</p> |
| <p>🕒 Every 8 h</p> | | | |
| <p>Check fluid levels. See Section 5-3.</p> |  <p>OIL Full</p> | <p>Wipe up spills.</p> |  |
| <p>🕒 Every 20 h</p> | | <p>🕒 Every 25 h</p> | |
| <p>Check and clean spark arrestor screen. See Section 9-4.</p> |  | <p>Service air filter wrapper (foam element). See Section 9-3.</p> |  |
| <p>🕒 Every 50 h</p> | | | |
| <p>Clean and tighten weld terminals.</p> | |  | |
| <p>🕒 Every 100 h</p> | | | |
| <p>Change oil. See Section 9-5 and maintenance label.</p> |  | <p>Service air filter element. See Section 9-3.</p> |  |
| <p>Clean cooling system. See engine manual.</p> |  | <p>Clean and tighten battery connections.</p> |  |
| <p>🕒 Every 200 h</p> | | | |
| <p>Change oil filter. See Section 9-5 and maintenance label.</p> |  | <p>Replace fuel filter. See Section 9-5.</p> |  |
| <p>Check spark plugs.</p> |  | <p>Replace unreadable labels.</p> |  |
| <p>🕒 Every 500 h</p> | | | |
| <p>Repair or replace cracked cables.</p> |  | <p>Service welding generator brushes and slip rings. Service more often in dirty conditions.*</p> |  |
| <p>🕒 Every 1000 h</p> | | | |
| <p>Blow out or vacuum inside. During heavy service, clean monthly.</p> | |  <p>OR</p> | |

9-2. Maintenance Label (Kohler-Powered Units)

NOTE



Follow the storage procedure in the engine owner's manual if the unit will not be used for an extended period.

KOHLER CH20 AND ONAN OHV 220 GAS ENGINES



Check Daily.

To Drain Oil:
Push And Turn CCW

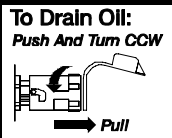

Pull

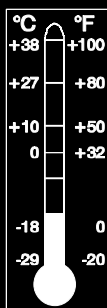

| KOHLER | | ONAN | |
|--------|--------------|------|----------------|
| ↑ | 10W-30 | ↑ | 30 |
| ↓ | 5W-20, 5W-30 | ↓ | 10W-30, 10W-40 |
| | | | 5W-30 |

See Engine Manual for complete engine care. Give Engine Specification and Serial Number when ordering parts.

Recommended Oil
API Service Classification SG or higher
(If using LP fuel, use synthetic oil.)

Oil Change 100 hours
Oil Filter Change 200 hours
Oil Filter **KOHLER:** MILLER 066 698, Kohler 1205001
ONAN: MILLER 198 754, Onan 122-0737-03

Oil Capacity w/filter change Approximately 1.5 quarts

DO NOT OVERFILL . . .
KOHLER: Keep oil level between L & F marks on dipstick.
ONAN: Keep oil level between 2 holes on dipstick.



Gasoline

Fuel Grade Unleaded, 87 Octane min.
Fuel Filter **KOHLER:** MILLER 215 984, Kohler 2505008
ONAN: MILLER 215 984, Onan 149-2206-01



Air Filter Service 100 hours – see Owner's Manual
Air Filter **KOHLER:** MILLER 067 272, Kohler 4708303
Air Filter Wrapper **KOHLER:** MILLER 067 273, Kohler 2408302
Air Filter **ONAN:** MILLER 198 755, Onan 187-6068
(Includes Air Filter Wrapper)



12 Volt Battery BCI Group 58
Cranking Performance at 0°F (-18°C) . . . 430 Amps min.



Engine Speed
No Load
High Speed . . . 3675-3750 RPM
Idle 2200-2300 RPM
Miller Legend. . See Owner's Manual

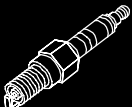

Spark Plug **KOHLER:** Champion RC-12YC Gap: 0.030 in.
ONAN: NGK BPR4EY Gap: 0.025 in.
Use only resistor spark plugs and wires.

Tune-up and Filter Kit . . (Includes Air, Oil and Fuel Filters, and 2 Spark Plugs)
KOHLER: MILLER 180 096
ONAN: MILLER 199 062

215 939-B

9-3. Servicing Air Cleaner (Kohler-Powered Units)

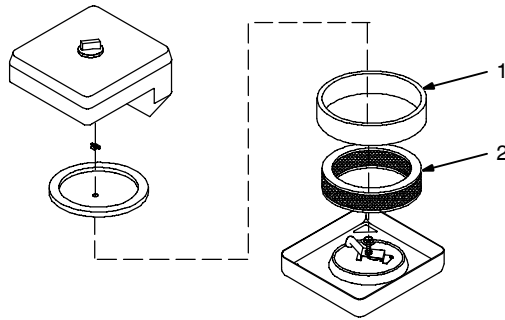
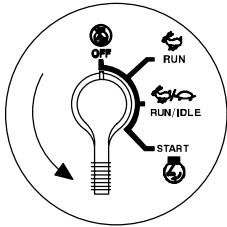

- ▲ Stop engine.
- ▲ Do not run engine without air cleaner or with dirty element.

1 Wrapper (Foam Element)

Wash wrapper with soap and water solution. Allow wrapper to air dry completely.

Spread 1 tablespoon SAE 30 oil evenly into wrapper. Squeeze out excess oil.

2 Element

Replace element if damaged, dirty, or oily.

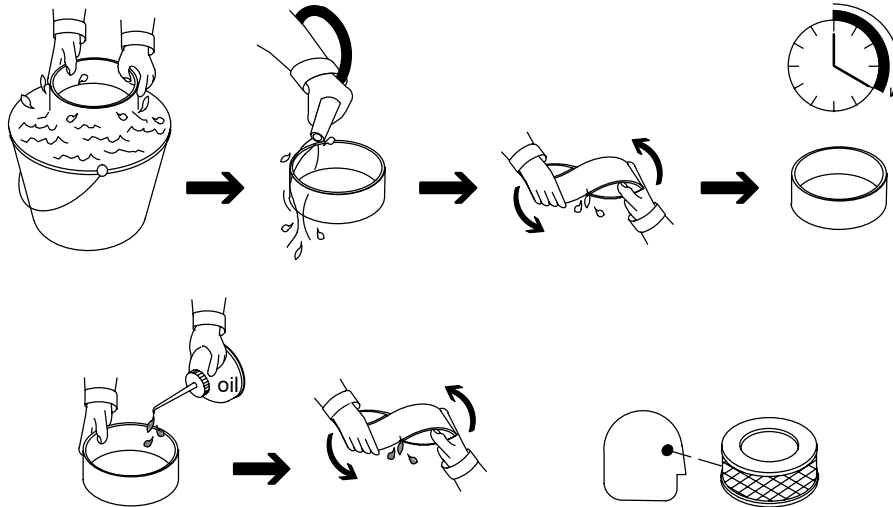

aircleaner3 9/00 - 802 772 / Ref. 185 095-A / S-0759

9-4. Servicing Optional Spark Arrestor (Kohler-Powered Units)

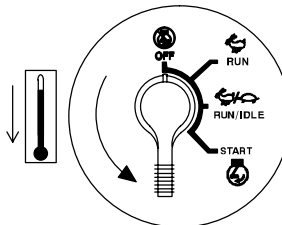
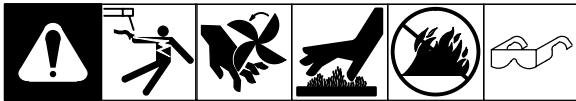

- ▲ Stop engine and let cool.

1 Spark Arrestor Screen

Clean and inspect screen. Replace spark arrestor if screen wires are broken or missing.

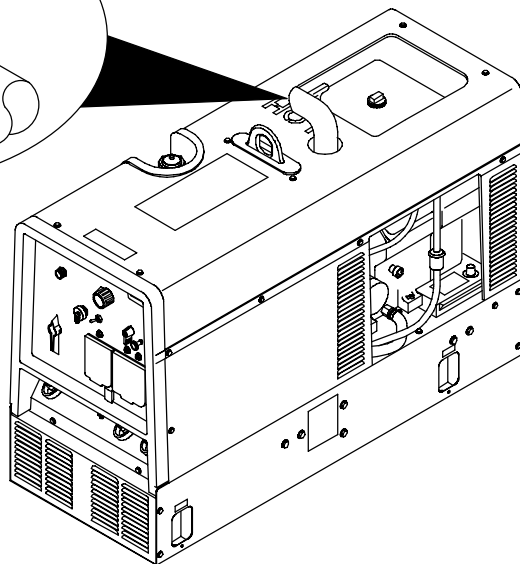
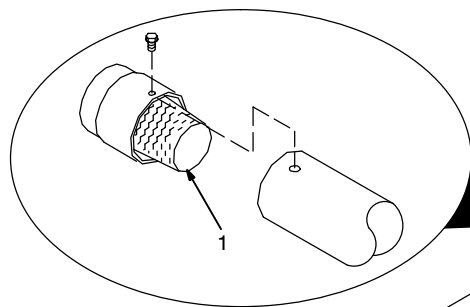

Tools Needed:

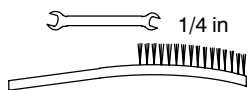

802 849-A / Ref. 206 422

9-5. Changing Engine Oil, Oil Filter, And Fuel Filter (Kohler-Powered Units)

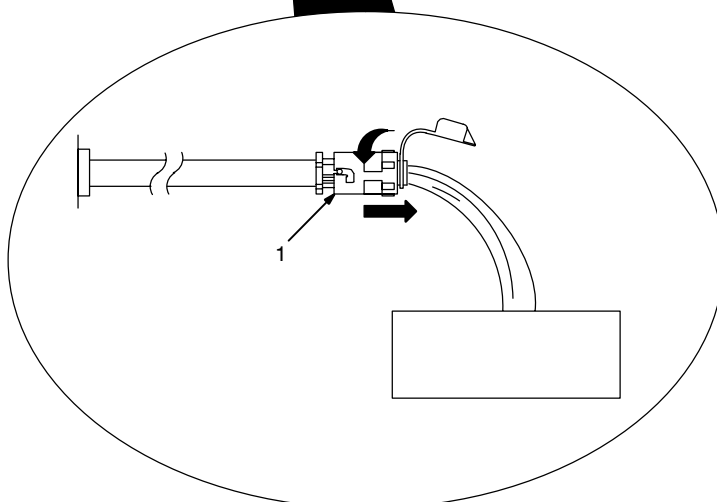
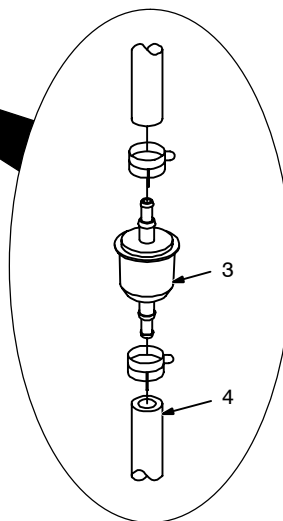
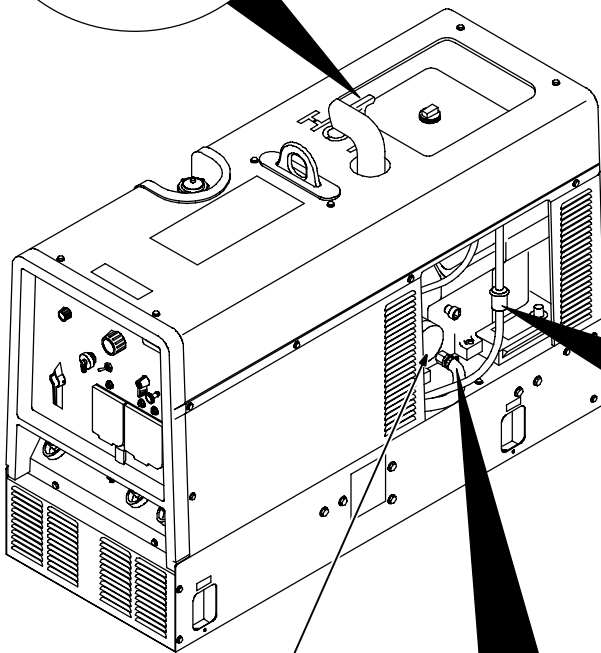
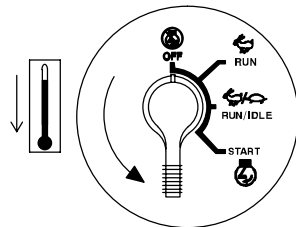
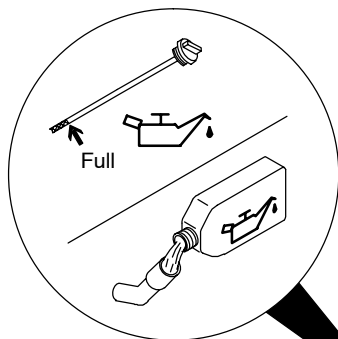

Tools Needed:

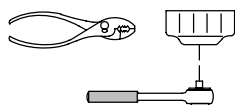

▲ **Stop engine and let cool.**

- 1 Oil Drain Valve
- 2 Oil Filter

Change engine oil and filter according to engine manual.

▲ **Close valve and valve cap before adding oil and running engine.**

Fill crankcase with new oil to full mark on dipstick (see Section 9-2).

- 3 Fuel Filter
- 4 Fuel Line

Replace line if cracked or worn. Install new filter. Wipe up any spilled fuel.

Start engine, and check for fuel leaks.

▲ **Stop engine, tighten connections as necessary, and wipe up fuel.**

9-6. Adjusting Engine Speed (Kohler-Powered Units)



| | |
|--|---------------|
| | |
| | 2200 ± 50 rpm |
| | 3700 ± 50 rpm |

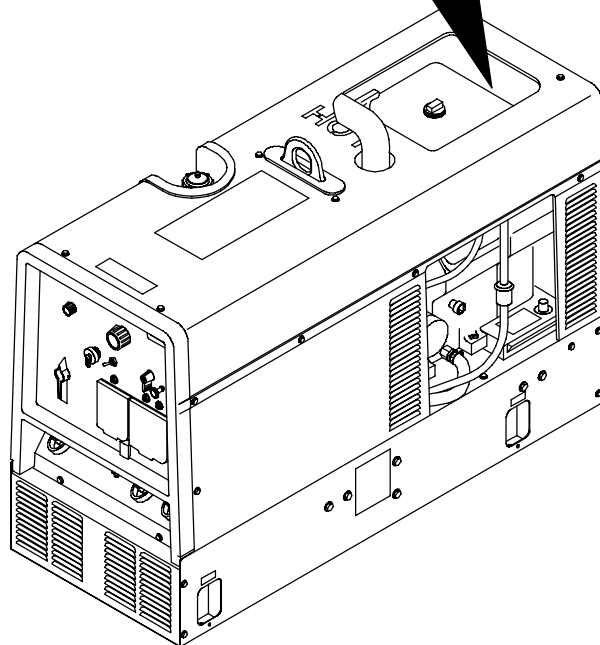
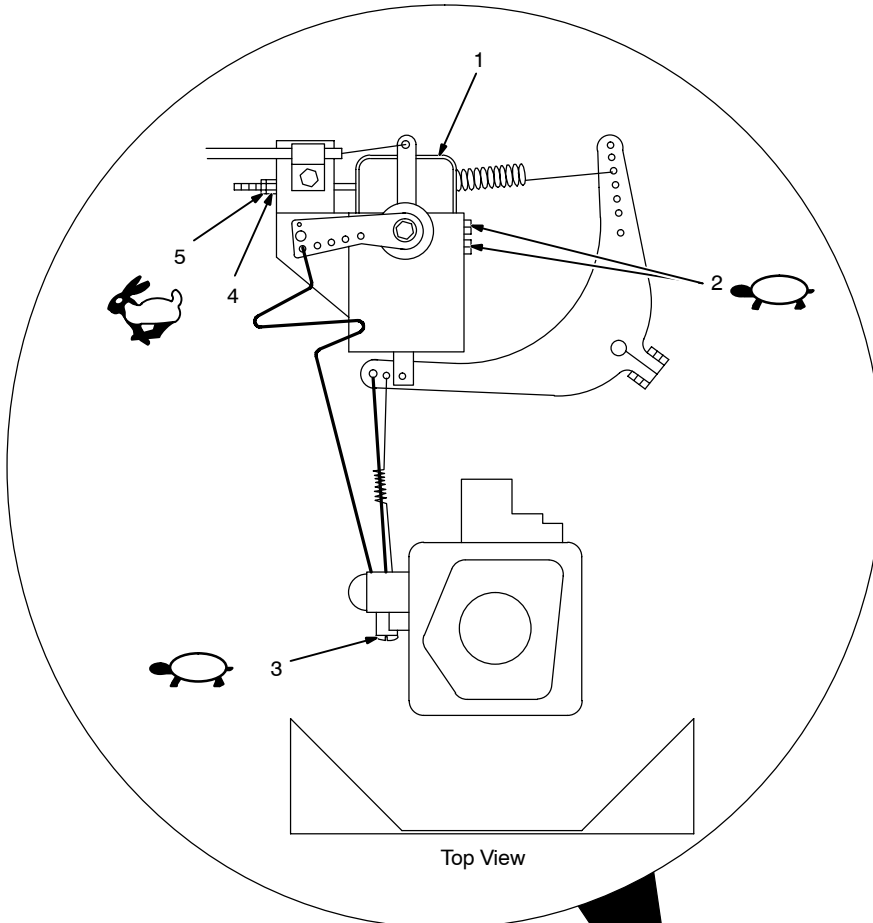

Tools Needed:

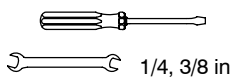

After tuning engine, check engine speeds with a tachometer (see table). If necessary, adjust speeds as follows:

Start engine and run until warm. Turn A/V control to 10.

Remove top cover to access speed adjustments.

Idle Speed Adjustment

Move Engine Control switch to Run/Idle position.

- 1 Throttle Solenoid
- 2 Mounting Screws
- 3 Idle Speed Screw

Loosen mounting screws. Adjust solenoid position so engine runs at idle speed. If necessary, back out idle speed screw so solenoid can be moved to correct position. Tighten mounting screws. Be sure solenoid linkage works smoothly.

Turn idle speed screw for fine adjustments.

Weld/Power Speed Adjustment

Move Engine Control switch to Run position.

- 4 Weld/Power Speed Adjustment Nut
- 5 Lock Nut

Loosen lock nut. Turn adjustment nut until engine runs at weld/power speed. Tighten lock nut.

Reinstall top cover.

▲ **Stop engine.**

9-7. Overload Protection (Kohler-Powered Units)



Tools Needed:

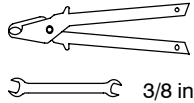

▲ Stop engine.

☞ *When a circuit breaker or fuse opens, it usually indicates a more serious problem exists. Contact a Factory Authorized Service Agent.*

1 Circuit Breaker CB5

CB5 protects the 24 volt ac output to Remote receptacle RC4. If CB5 opens, 24 volt ac output to RC4 stops.

Press button to reset breaker.

2 Fuse F2 (See Parts List)

F2 is located behind the front panel. F2 protects the 115 volt output to Remote Receptacle RC4. If F2 opens, 115 volt ac output to RC4 stops.

F6 protects the engine wiring system from overload. If F6 opens, engine will not crank.

4 Fuse F1 (See Parts List)

Remove side panel.

F1 protects the exciter excitation winding from overload. If F1 opens, weld and generator power output stops.

Replace any open fuses. Reinstall cover before operating unit.

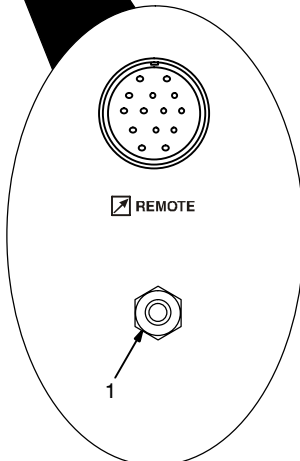
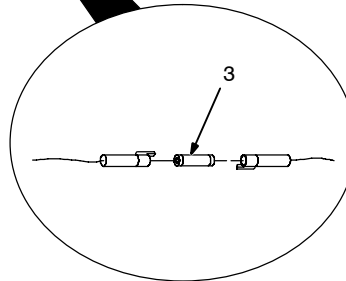
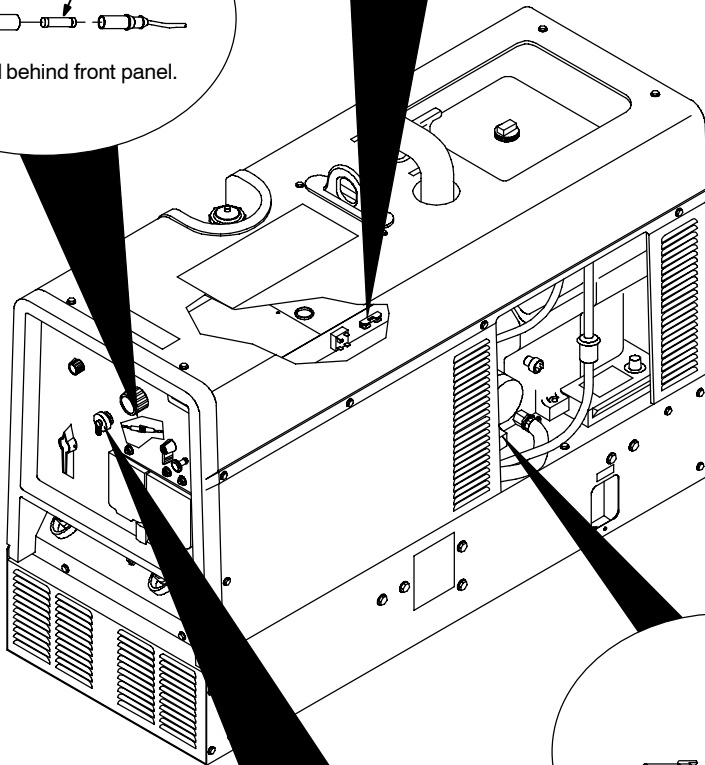
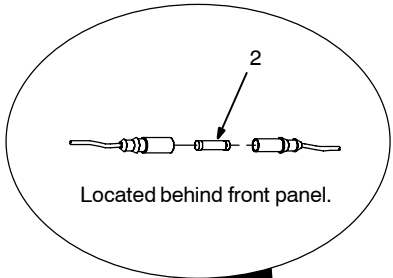
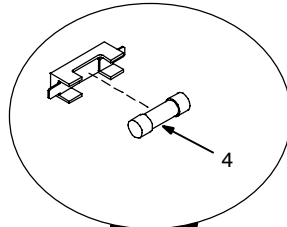
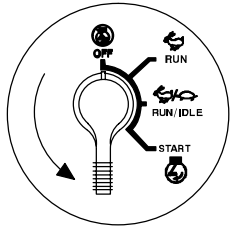

SECTION 10 – TROUBLESHOOTING

10-1. Welding Troubleshooting

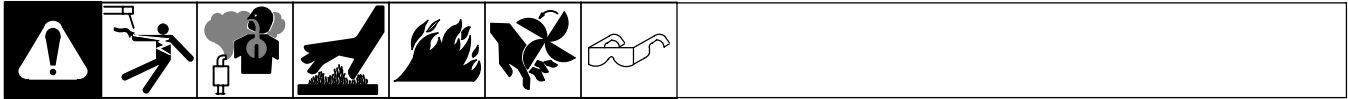

| Trouble | Remedy |
|--|--|
| No weld output. | Check control settings. |
| | Check weld connections. |
| | Disconnect equipment from generator power receptacles during start-up. |
| | Place V/A Adjust switch in Panel position, or move switch to Remote position and connect remote control to Remote receptacle RC4 (see Sections 5-9 and 6-1). |
| | Check and secure connections to Remote receptacle RC4 (see Sections 5-9). |
| | Check fuse F1, and replace if necessary (see Section 8-5 or 9-7). |
| | Have Factory Authorized Service Agent check brushes, slip rings, integrated rectifier SR2, and circuit boards PC1 and PC2. |
| Low weld output. | Check control settings. |
| | Place V/A Adjust switch in Panel position, or move switch to Remote position and connect remote control to Remote receptacle RC4 (see Sections 5-9 and 6-1). |
| | Check and clean air cleaner as necessary (see Section 8-3 or 9-3). |
| | Check engine speed, and adjust if necessary (see Section 8-7 or 9-6). |
| | Have Factory Authorized Service Agent check brushes, slip rings, integrated rectifier SR2, and circuit boards PC1 and PC2. |
| | See engine manual. |
| High weld output. | Check control settings. |
| | Check and adjust engine speed (see Section 8-7 or 9-6). |
| | Check for obstructed movement of solenoid linkage (see Section 8-7 or 9-6). |
| | Have Factory Authorized Service Agent check circuit boards PC1 and PC2. |
| Weld output cannot be adjusted. | Check position of V/A Adjust switch (see Section 6-1). |
| | Have Factory Authorized Service Agent check field current control board PC2. |
| Erratic weld output. | Check control settings. |
| | Clean and tighten connections both inside and outside unit. |
| | Check and secure lead connections to A/V control. |
| | Be sure connection to work piece is clean and tight. |
| | Remove excessive coils from weld cables. |
| | Use dry, properly stored electrodes. |
| | Check and adjust engine speed (see Section 8-7 or 9-6). |
| | Have Factory Authorized Service Agent check brushes, slip rings, and circuit boards PC1 and PC2. |
| No remote fine amperage control. | Place V/A Adjust switch in correct position (see Section 6-1). |
| | Check and tighten connections to Remote receptacle RC4 (see Section 5-9). |
| No 24 volt ac power output at Remote receptacle RC4. | Reset circuit breaker CB5 (see Section 8-5 or 9-7). |
| | Check fuse F2, and replace if necessary (see Section 8-5 or 9-7). Reset circuit breaker CB1 (see Section 7-1). |

| Trouble | Remedy |
|--|--|
| Lack of high frequency; difficulty in establishing Gas Tungsten Arc Welding arc. | Use proper size tungsten for welding amperage. |
| | Reduce leakage of high frequency from torch or work cable (check grounding, remove excessive coils from weld cables, use shorter weld cables, etc.). |
| | Check cables and torch for cracked or deteriorated insulation or bad connections. Repair or replace necessary parts. |
| Wandering arc – poor control of arc direction. | Reduce gas flow rate. |
| | Select proper size tungsten. Properly prepare tungsten. |
| Tungsten electrode oxidizing and not remaining bright after conclusion of weld. | Shield weld zone from drafts. |
| | Increase postflow time. |
| | Check and tighten all gas fittings. |
| | Properly prepare tungsten. |

10-2. Generator Power Troubleshooting

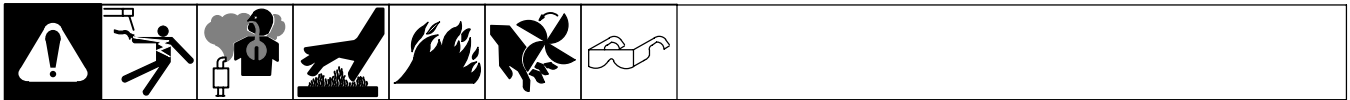

| Trouble | Remedy |
|-----------------------|--|
| No power output. | Reset circuit breakers CB1, CB3 and/or CB4 (see Section 7-1). |
| | Check fuse F1, and replace if necessary (see Section 8-5 or 9-7). |
| | Have Factory Authorized Service Agent check brushes, slip rings, integrated rectifier SR2, and circuit boards PC1 and PC2. |
| Low power output. | Check and clean air cleaner as necessary. |
| | Check engine speed, and adjust if necessary (see Section 8-7 or 9-6). |
| | See engine manual. |
| High power output. | Check engine speed, and adjust if necessary (see Section 8-7 or 9-6). |
| Erratic power output. | Have Factory Authorized Service Agent check brushes, slip rings, and field current control board PC2. |
| | Check receptacle wiring and connections. |
| | Check governor according to engine manual. |

10-3. Engine Troubleshooting

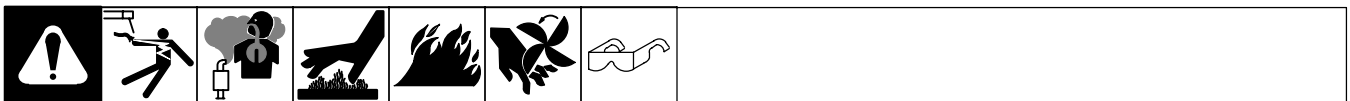

| Trouble | Remedy |
|------------------------|---|
| Engine will not crank. | Check fuse F6, and replace if open (see Section 8-5 or 9-7). |
| | Check battery voltage. |
| | Check battery connections and tighten if necessary. |
| | Check plug PLG5 and plug PLG8 connections. |
| | Have Factory Authorized Service Agent check Engine Control switch S2. |

| Trouble | Remedy |
|--|---|
| Engine does not start. | Check fuel level (see Section 5-2 or 5-3). |
| | Check battery and replace if necessary. |
| | Check engine charging system according to engine manual. |
| | Have Factory Authorized Service Agent check fuel shutoff solenoid GS1 according to engine manual (GS1 standard on Kohler-powered units; optional on Robin-powered, LP-fueled units). |
| | See engine manual. |
| Engine starts but stops when Engine Control switch returns to Run/Idle position. | Check oil level (see Section 5-2 or 5-3). Low oil pressure shutdown stops engine if oil pressure is too low. |
| | Use correct grade oil for operating temperature. (see Section 8-1 or 9-2). |
| | Have Factory Authorized Service Agent check low oil pressure shutdown switch S5. |
| Battery discharges between uses. | Place Engine Control switch in Off position when unit is not running. |
| | Clean top of battery with baking soda and water solution; rinse with clear water. |
| | Periodically recharge battery (approximately every 3 months). |
| | Replace battery. |
| | Check voltage regulator according to engine manual. |
| Engine stopped during normal operation. | Check fuel level (see Section 5-2 or 5-3). |
| | Check oil level (see Section 5-2 or 5-3). Low oil pressure shutdown stops engine if oil pressure is too low. |
| | Have Factory Authorized Service Agent check fuel shutoff solenoid GS1 according to engine manual (GS1 standard on Kohler-powered units; optional on Robin-powered, LP-fueled units). |
| | Have Factory Authorized Service Agent check low oil pressure shutdown switch S5. |
| Engine does not return to idle speed. | Be sure Engine Control switch S2 is in Run/Idle position. |
| | Remove all weld and generator power loads. |
| | Place Process/Contactor switch in Electrode Hot position or turn off remote contactor. The unit will not return to idle speed when Process/Contactor switch is in a remote position and the remote contactor is on. |
| | Turn off remote device connected to Remote receptacle RC4 (see Section 5-9). |
| | Check for obstructed movement of solenoid linkage (see Section 8-7 or 9-6). |
| | Have Factory Authorized Service Agent check circuit board PC1 and current transformer CT1. |
| Engine does not remain at weld/power speed when power or weld load is applied with Engine Control switch in Run/Idle position. | Place Engine Control switch in the Run position for small loads. |
| | Check for obstructed movement of solenoid linkage (see Section 8-7 or 9-6). |

SECTION 11 – ELECTRICAL DIAGRAMS

| | |
|--|--|
|  | WARNING |
| | <ul style="list-style-type: none"> Do not touch live electrical parts. Disconnect input power or stop engine before servicing. Do not operate with covers removed. Have only qualified persons install, use, or service this unit. |
| ELECTRIC SHOCK HAZARD | |

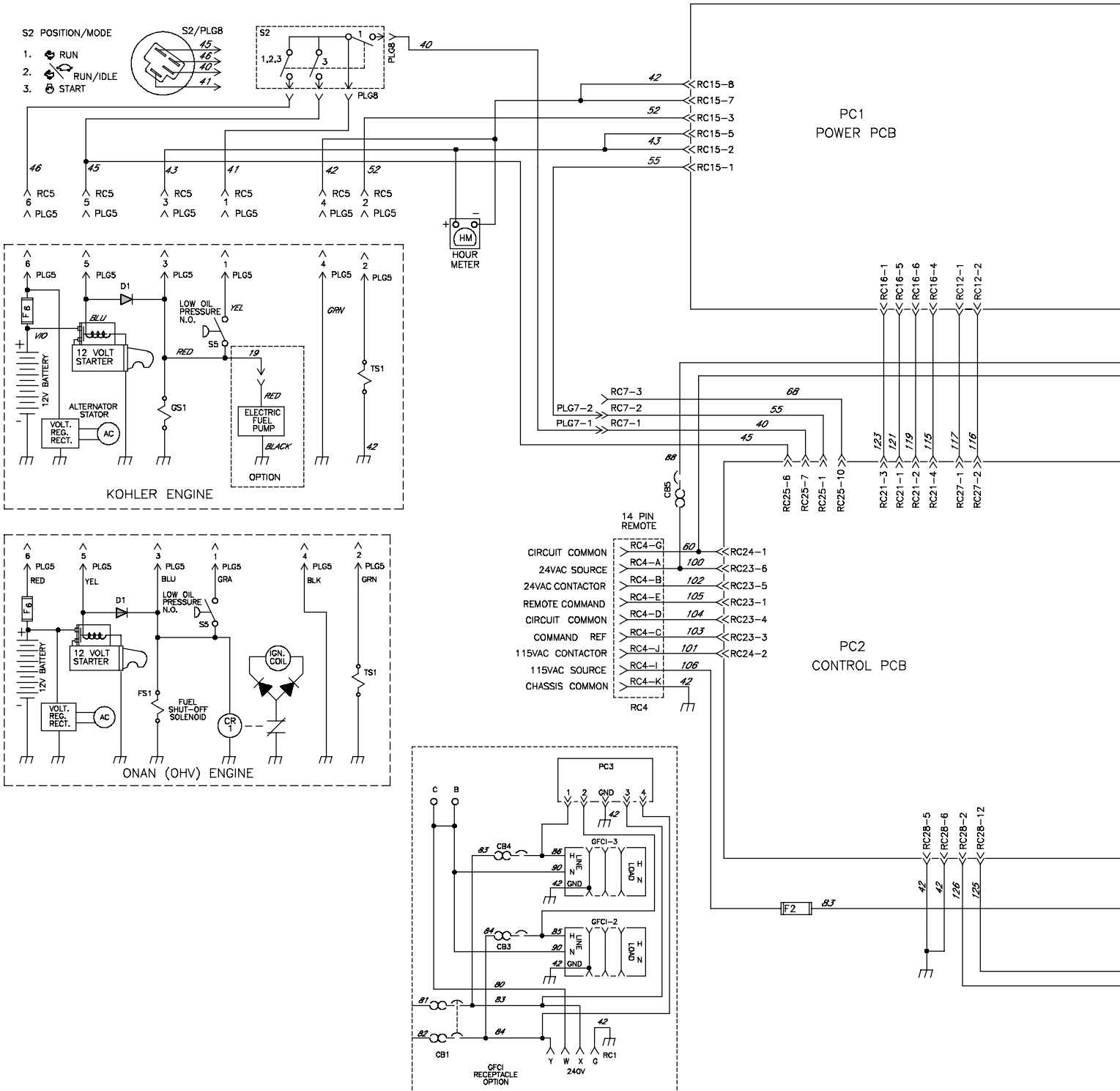



Figure 11-1. Circuit Diagram For Welding Generator Models With AC/DC Output

| | |
|---|--|
|  ELECTRIC SHOCK HAZARD | WARNING |
| | <ul style="list-style-type: none"> • Do not touch live electrical parts. • Disconnect input power or stop engine before servicing. • Do not operate with covers removed. • Have only qualified persons install, use, or service this unit. |

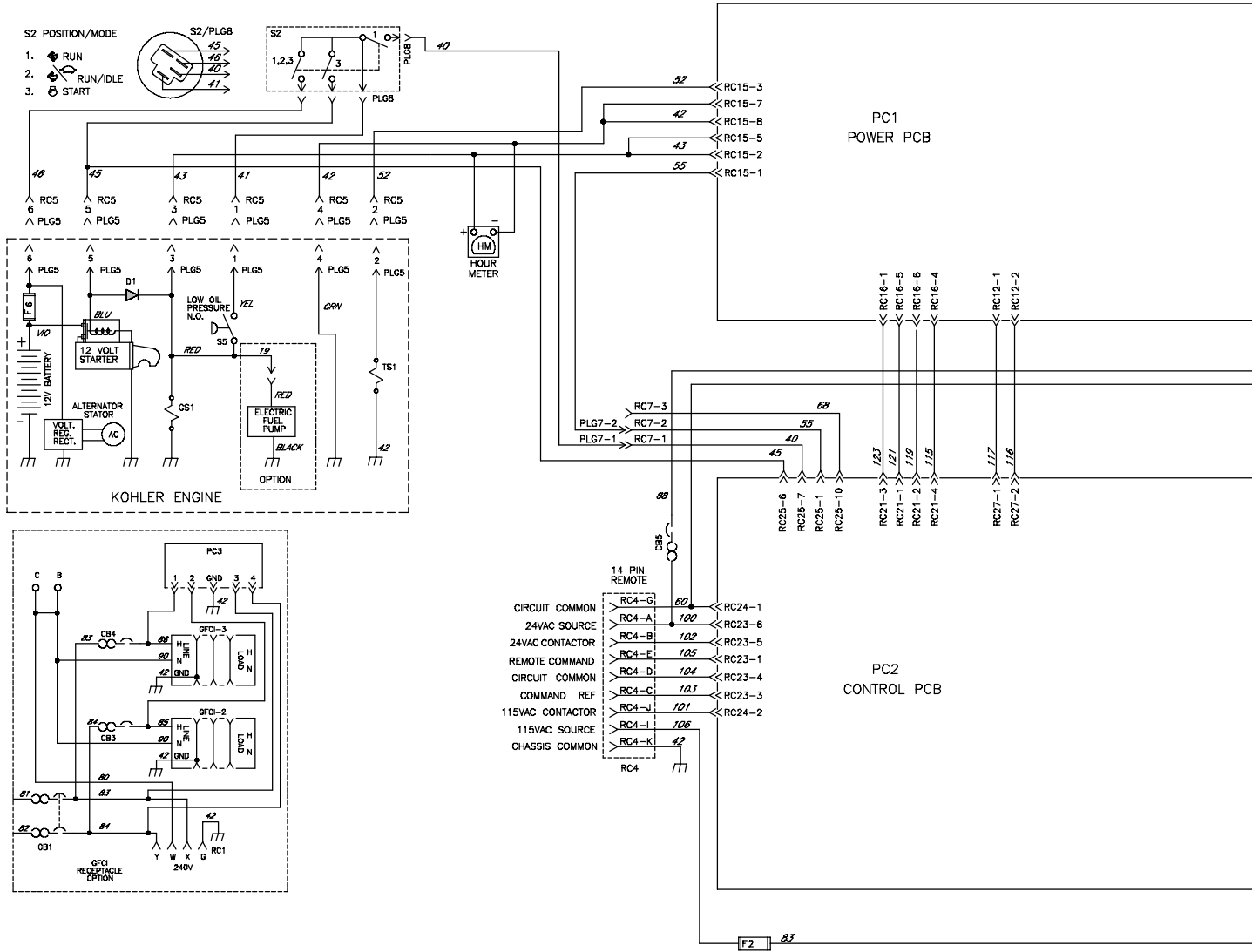
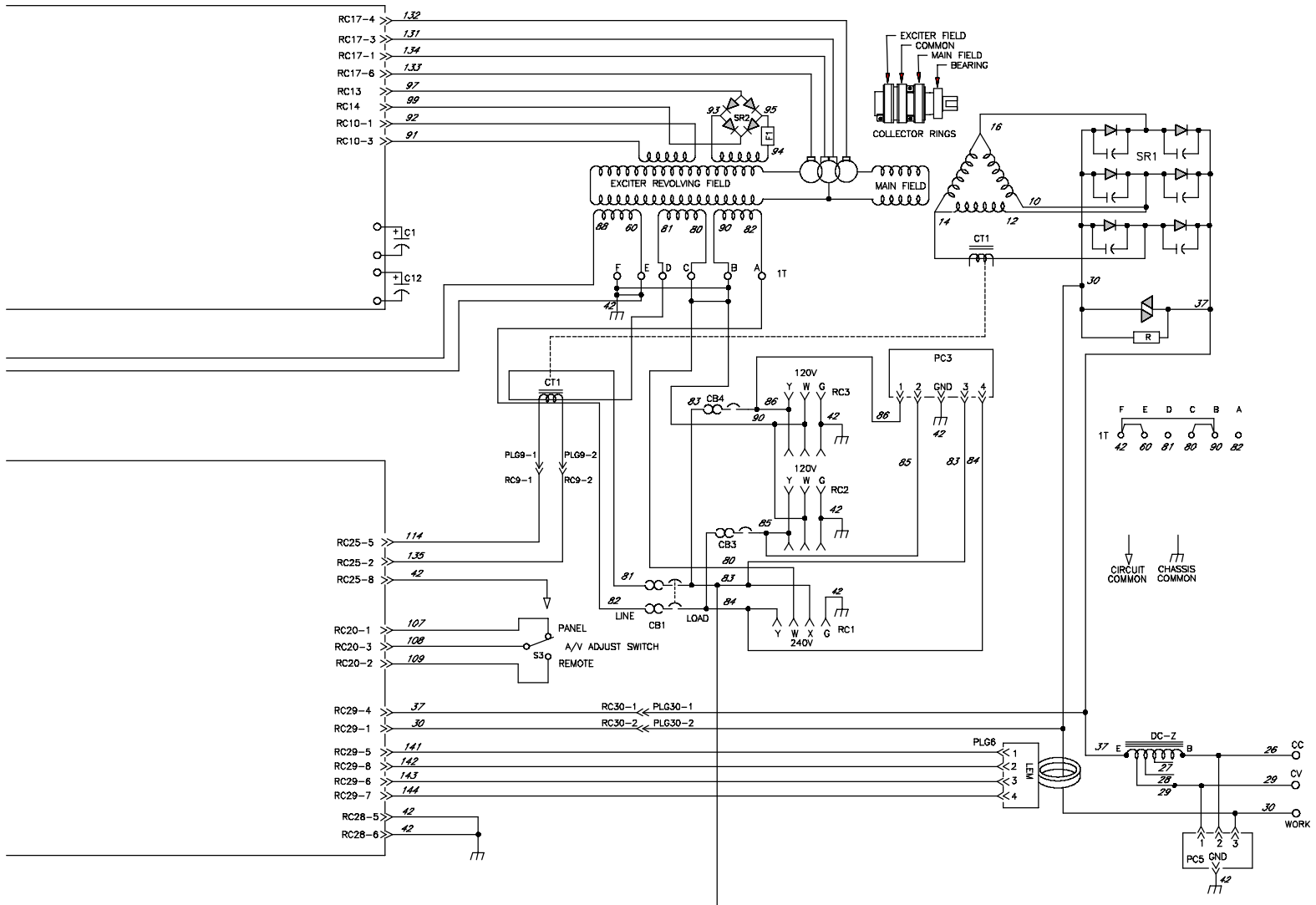

Figure 11-2. Circuit Diagram For Welding Generator Models With DC Output Only (Kohler Only)



SECTION 12 – GENERATOR POWER GUIDELINES

NOTE

The views in this section are intended to be representative of all engine-driven welding generators. Your unit may differ from those shown.

12-1. Selecting Equipment

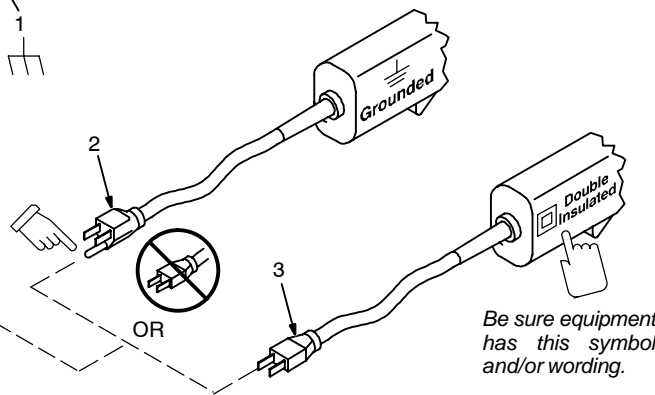
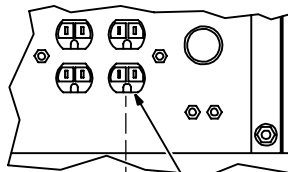

- 1 Generator Power Receptacles – Neutral Bonded To Frame
 - 2 3-Prong Plug From Case Grounded Equipment
 - 3 2-Prong Plug From Double Insulated Equipment
- ▲ **Do not use 2-prong plug unless equipment is double insulated.**

gen_pwr 11/02 – Ref. ST-159 730 / ST-800 577

12-2. Grounding Generator To Truck Or Trailer Frame

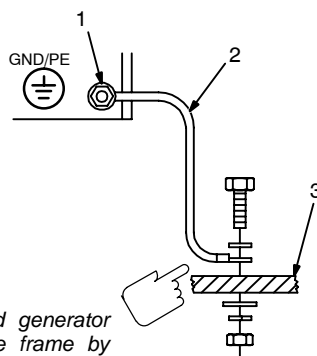
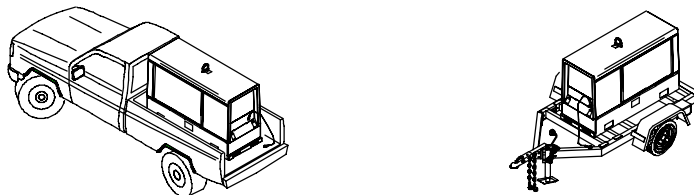

Electrically bond generator frame to vehicle frame by metal-to-metal contact.

- ▲ **Bed liners, shipping skids, and some running gear insulate the welding generator from the vehicle frame. Always connect a ground wire from the generator equipment grounding terminal to bare metal on the vehicle frame as shown.**

- ▲ **Always ground generator frame to vehicle frame to prevent electric shock and static electricity hazards.**

- 1 Equipment Grounding Terminal (On Front Panel)
- 2 Grounding Cable (Not Supplied)
- 3 Metal Vehicle Frame

Connect cable from equipment ground terminal to metal vehicle frame. Use #10 AWG or larger insulated copper wire.

- ▲ **If unit does not have GFCI receptacles, use GFCI-protected extension cord.**

S-0854

12-3. Grounding When Supplying Building Systems

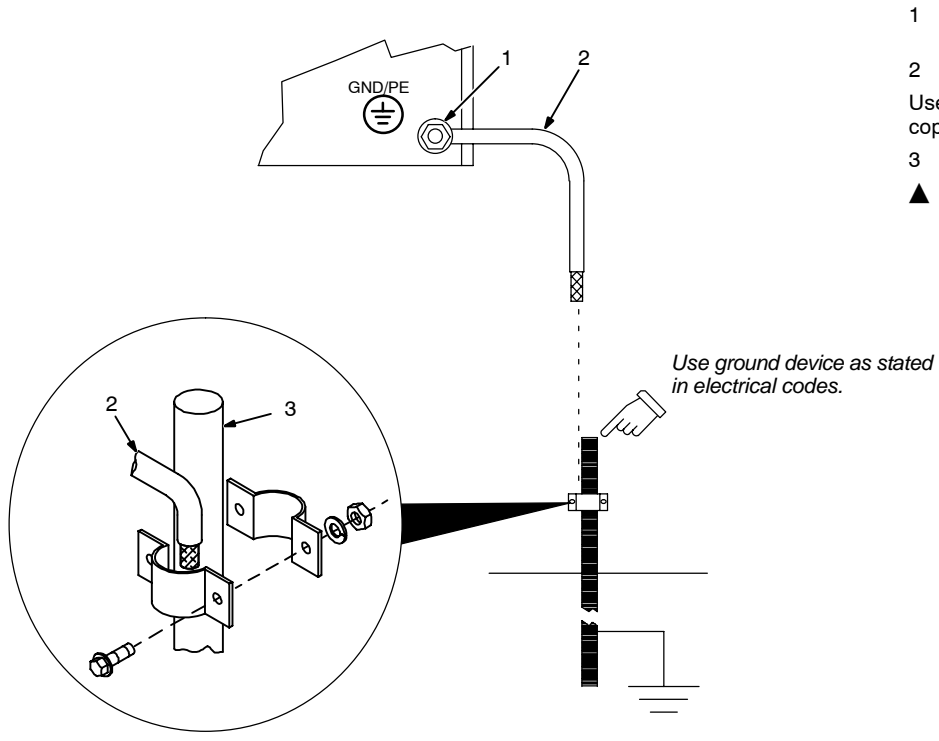

- 1 Equipment Grounding Terminal
 - 2 Grounding Cable
Use #10 AWG or larger insulated copper wire.
 - 3 Ground Device
- ▲ **Ground generator to system earth ground if supplying power to a premises (home, shop, farm) wiring system.**

ST-800 576-B

12-4. How Much Power Does Equipment Require?

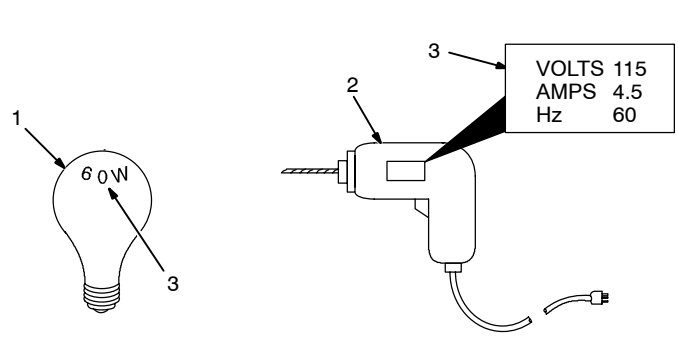

- 1 Resistive Load
A light bulb is a resistive load and requires a constant amount of power.
- 2 Non-Resistive Load
Equipment with a motor is a non-resistive load and requires approximately six times more power while starting the motor than when running (see Section 12-8).
- 3 Rating Data
Rating shows volts and amperes, or watts required to run equipment.

AMPERES x VOLTS = WATTS

EXAMPLE 1: If a drill uses 4.5 amperes at 115 volts, calculate its running power requirement in watts.

$$4.5 \text{ A} \times 115 \text{ V} = 520 \text{ W}$$

The load applied by the drill is 520 watts.

EXAMPLE 2: If three 200 watt flood lamps are used with the drill from Example 1, add the individual loads to calculate total load.

$$(200 \text{ W} + 200 \text{ W} + 200 \text{ W}) + 520 \text{ W} = 1120 \text{ W}$$

The total load applied by the three flood lamps and drill is 1120 watts.

S-0623

12-5. Approximate Power Requirements For Industrial Motors

| Industrial Motors | Rating | Starting Watts | Running Watts |
|-------------------------------|----------|----------------|---------------|
| Split Phase | 1/8 HP | 800 | 300 |
| | 1/6 HP | 1225 | 500 |
| | 1/4 HP | 1600 | 600 |
| | 1/3 HP | 2100 | 700 |
| | 1/2 HP | 3175 | 875 |
| Capacitor Start-Induction Run | 1/3 HP | 2020 | 720 |
| | 1/2 HP | 3075 | 975 |
| | 3/4 HP | 4500 | 1400 |
| | 1 HP | 6100 | 1600 |
| | 1-1/2 HP | 8200 | 2200 |
| | 2 HP | 10550 | 2850 |
| | 3 HP | 15900 | 3900 |
| Capacitor Start-Capacitor Run | 5 HP | 23300 | 6800 |
| | 1-1/2 HP | 8100 | 2000 |
| | 5 HP | 23300 | 6000 |
| | 7-1/2 HP | 35000 | 8000 |
| Fan Duty | 10 HP | 46700 | 10700 |
| | 1/8 HP | 1000 | 400 |
| | 1/6 HP | 1400 | 550 |
| | 1/4 HP | 1850 | 650 |
| | 1/3 HP | 2400 | 800 |
| | 1/2 HP | 3500 | 1100 |

12-6. Approximate Power Requirements For Farm/Home Equipment

| Farm/Home Equipment | Rating | Starting Watts | Running Watts |
|----------------------------|----------|----------------|---------------|
| Stock Tank De-Icer | | 1000 | 1000 |
| Grain Cleaner | 1/4 HP | 1650 | 650 |
| Portable Conveyor | 1/2 HP | 3400 | 1000 |
| Grain Elevator | 3/4 HP | 4400 | 1400 |
| Milk Cooler | | 2900 | 1100 |
| Milker (Vacuum Pump) | 2 HP | 10500 | 2800 |
| FARM DUTY MOTORS | 1/3 HP | 1720 | 720 |
| Std. (e.g. Conveyors, | 1/2 HP | 2575 | 975 |
| Feed Augers, Air | 3/4 HP | 4500 | 1400 |
| Compressors) | 1 HP | 6100 | 1600 |
| | 1-1/2 HP | 8200 | 2200 |
| | 2 HP | 10550 | 2850 |
| | 3 HP | 15900 | 3900 |
| | 5 HP | 23300 | 6800 |
| High Torque (e.g. Barn | 1-1/2 HP | 8100 | 2000 |
| Cleaners, Silo Unloaders, | 5 HP | 23300 | 6000 |
| Silo Hoists, Bunk Feeders) | 7-1/2 HP | 35000 | 8000 |
| | 10 HP | 46700 | 10700 |
| 3-1/2 cu. ft. Mixer | 1/2 HP | 3300 | 1000 |
| High Pressure 1.8 Gal/Min | 500 PSI | 3150 | 950 |
| Washer 2 gal/min | 550 PSI | 4500 | 1400 |
| 2 gal/min | 700 PSI | 6100 | 1600 |
| Refrigerator or Freezer | | 3100 | 800 |
| Shallow Well Pump | 1/3 HP | 2150 | 750 |
| | 1/2 HP | 3100 | 1000 |
| Sump Pump | 1/3 HP | 2100 | 800 |
| | 1/2 HP | 3200 | 1050 |

12-7. Approximate Power Requirements For Contractor Equipment

| Contractor | Rating | Starting Watts | Running Watts |
|----------------------|------------------|----------------|---------------|
| Hand Drill | 1/4 in | 350 | 350 |
| | 3/8 in | 400 | 400 |
| | 1/2 in | 600 | 600 |
| Circular Saw | 6-1/2 in | 500 | 500 |
| | 7-1/4 in | 900 | 900 |
| | 8-1/4 in | 1400 | 1400 |
| Table Saw | 9 in | 4500 | 1500 |
| | 10 in | 6300 | 1800 |
| Band Saw | 14 in | 2500 | 1100 |
| Bench Grinder | 6 in | 1720 | 720 |
| | 8 in | 3900 | 1400 |
| | 10 in | 5200 | 1600 |
| Air Compressor | 1/2 HP | 3000 | 1000 |
| | 1 HP | 6000 | 1500 |
| | 1-1/2 HP | 8200 | 2200 |
| | 2 HP | 10500 | 2800 |
| Electric Chain Saw | 1-1/2 HP, 12 in | 1100 | 1100 |
| | 2 HP, 14 in | 1100 | 1100 |
| Electric Trimmer | Standard 9 in | 350 | 350 |
| | Heavy Duty 12 in | 500 | 500 |
| Electric Cultivator | 1/3 HP | 2100 | 700 |
| Elec. Hedge Trimmer | 18 in | 400 | 400 |
| Flood Lights | HID | 125 | 100 |
| | Metal Halide | 313 | 250 |
| | Mercury | 1000 | |
| | Sodium Vapor | 1400 | 1000 |
| Submersible Pump | 400 gph | 600 | 200 |
| Centrifugal Pump | 900 gph | 900 | 500 |
| Floor Polisher | 3/4 HP, 16 in | 4500 | 1400 |
| | 1 HP, 20 in | 6100 | 1600 |
| High Pressure Washer | 1/2 HP | 3150 | 950 |
| | 3/4 HP | 4500 | 1400 |
| | 1 HP | 6100 | 1600 |
| 55 gal Drum Mixer | 1/4 HP | 1900 | 700 |
| Wet & Dry Vac | 1.7 HP | 900 | 900 |
| | 2-1/2 HP | 1300 | 1300 |

12-8. Power Required To Start Motor

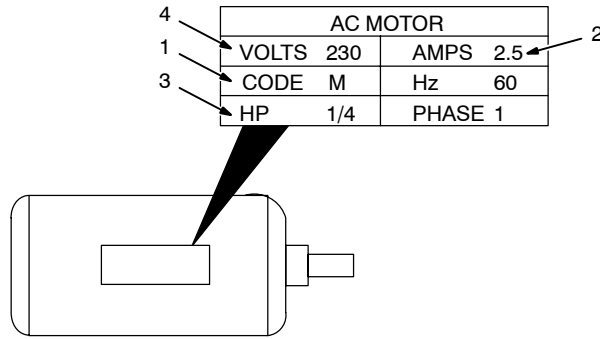

- 1 Motor Start Code
- 2 Running Amperage
- 3 Motor HP
- 4 Motor Voltage

To find starting amperage:

Step 1: Find code and use table to find kVA/HP. If code is not listed, multiply running amperage by six to find starting amperage.

Step 2: Find Motor HP and Volts.

Step 3: Determine starting amperage (see example).

Welding generator amperage output must be at least twice the motor's running amperage.

Single-Phase Induction Motor Starting Requirements

| Motor Start Code | G | H | J | K | L | M | N | P |
|------------------|-----|-----|-----|-----|------|------|------|------|
| KVA/HP | 6.3 | 7.1 | 8.0 | 9.0 | 10.0 | 11.2 | 12.5 | 14.0 |

$$\frac{\text{kVA/HP} \times \text{HP} \times 1000}{\text{VOLTS}} = \text{STARTING AMPERAGE}$$

EXAMPLE: Calculate the starting amperage required for a 230 V, 1/4 HP motor with a motor start code of M.

Volts = 230 HP = 1/4 Using Table, Code M results in kVA/HP = 11.2

$$\frac{11.2 \times 1/4 \times 1000}{230} = 12.2 \text{ A} \quad \text{Starting the motor requires 12.2 amperes.}$$

S-0624

12-9. How Much Power Can Generator Supply?

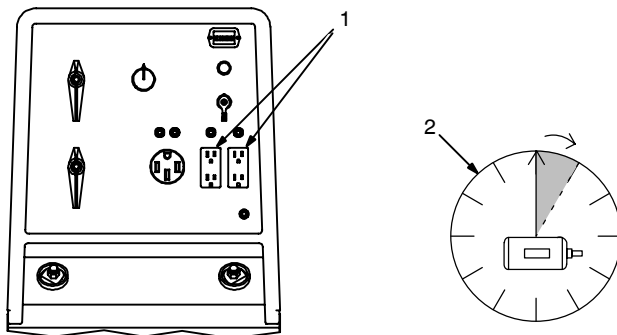

- 1 Limit Load To 90% Of Generator Output

Always start non-resistive (motor) loads in order from largest to smallest, and add resistive loads last.

- 2 5 Second Rule

If motor does not start within 5 seconds, turn off power to prevent motor damage. Motor requires more power than generator can supply.

Ref. ST-800 396-A / S-0625

12-10. Typical Connections To Supply Standby Power



▲ Properly install and ground this equipment according to its Owner's Manual and national, state, and local codes.

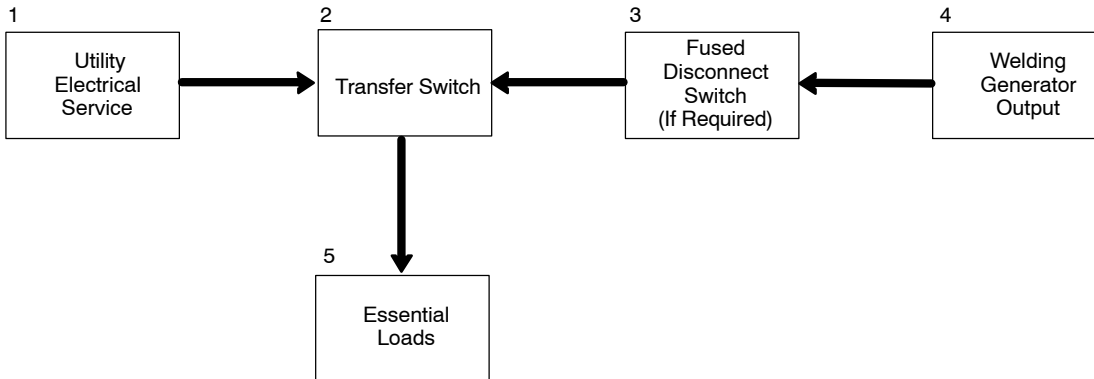

▲ **Have only qualified persons perform these connections according to all applicable codes and safety practices.**

▲ **Properly install and ground this equipment according to its Owner's Manual and national, state, and local codes.**

☞ Customer-supplied equipment is required if generator will supply standby power during emergencies or power outages.

1 Utility Electrical Service

2 Transfer Switch (Double-Throw)

Switch transfers the electrical load from electric utility service to the generator. Transfer load back to electric utility when service is restored.

Install correct switch (customer-supplied). Switch rating must be same as or greater than the branch overcurrent protection.

3 Fused Disconnect Switch

Install correct switch (customer-supplied) if required by electrical code.

4 Welding Generator Output

Generator output voltage and wiring must be consistent with regular (utility) system voltage and wiring.

Connect generator with temporary or permanent wiring suitable for the installation.

Turn off or unplug all equipment connected to generator before starting or stopping engine. When starting or stopping, the engine has low speed which causes low voltage and frequency.

5 Essential Loads

Generator output may not meet the electrical requirements of the premises. If generator does not produce enough output to meet all requirements, connect only essential loads (pumps, freezers, heaters, etc. – See Section 12-4).

Notes

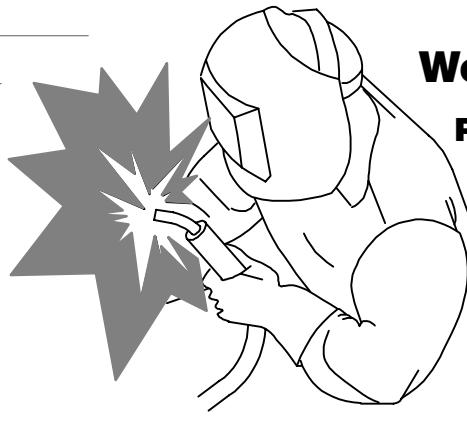

Work like a Pro!

Pros weld and cut safely. Read the safety rules at the beginning of this manual.

12-11. Selecting Extension Cord (Use Shortest Cord Possible)



Cord Lengths for 120 Volt Loads

▲ If unit does not have GFCI receptacles, use GFCI-protected extension cord.

| Current (Amperes) | Load (Watts) | Maximum Allowable Cord Length in ft (m) for Conductor Size (AWG)* | | | | | |
|-------------------|--------------|---|-----------|-----------|----------|----------|----------|
| | | 4 | 6 | 8 | 10 | 12 | 14 |
| 5 | 600 | | | 350 (106) | 225 (68) | 137 (42) | 100 (30) |
| 7 | 840 | | 400 (122) | 250 (76) | 150 (46) | 100 (30) | 62 (19) |
| 10 | 1200 | 400 (122) | 275 (84) | 175 (53) | 112 (34) | 62 (19) | 50 (15) |
| 15 | 1800 | 300 (91) | 175 (53) | 112 (34) | 75 (23) | 37 (11) | 30 (9) |
| 20 | 2400 | 225 (68) | 137 (42) | 87 (26) | 50 (15) | 30 (9) | |
| 25 | 3000 | 175 (53) | 112 (34) | 62 (19) | 37 (11) | | |
| 30 | 3600 | 150 (46) | 87 (26) | 50 (15) | 37 (11) | | |
| 35 | 4200 | 125 (38) | 75 (23) | 50 (15) | | | |
| 40 | 4800 | 112 (34) | 62 (19) | 37 (11) | | | |
| 45 | 5400 | 100 (30) | 62 (19) | | | | |
| 50 | 6000 | 87 (26) | 50 (15) | | | | |

*Conductor size is based on maximum 2% voltage drop

Cord Lengths for 240 Volt Loads

▲ If unit does not have GFCI receptacles, use GFCI-protected extension cord.

| Current (Amperes) | Load (Watts) | Maximum Allowable Cord Length in ft (m) for Conductor Size (AWG)* | | | | | |
|-------------------|--------------|---|-----------|-----------|-----------|----------|----------|
| | | 4 | 6 | 8 | 10 | 12 | 14 |
| 5 | 1200 | | | 700 (213) | 450 (137) | 225 (68) | 200 (61) |
| 7 | 1680 | | 800 (244) | 500 (152) | 300 (91) | 200 (61) | 125 (38) |
| 10 | 2400 | 800 (244) | 550 (168) | 350 (107) | 225 (69) | 125 (38) | 100 (31) |
| 15 | 3600 | 600 (183) | 350 (107) | 225 (69) | 150 (46) | 75 (23) | 60 (18) |
| 20 | 4800 | 450 (137) | 275 (84) | 175 (53) | 100 (31) | 60 (18) | |
| 25 | 6000 | 350 (107) | 225 (69) | 125 (38) | 75 (23) | | |
| 30 | 7000 | 300 (91) | 175 (53) | 100 (31) | 75 (23) | | |
| 35 | 8400 | 250 (76) | 150 (46) | 100 (31) | | | |
| 40 | 9600 | 225 (69) | 125 (38) | 75 (23) | | | |
| 45 | 10,800 | 200 (61) | 125 (38) | | | | |
| 50 | 12,000 | 175 (53) | 100 (31) | | | | |

*Conductor size is based on maximum 2% voltage drop

SECTION 13 – PARTS LIST

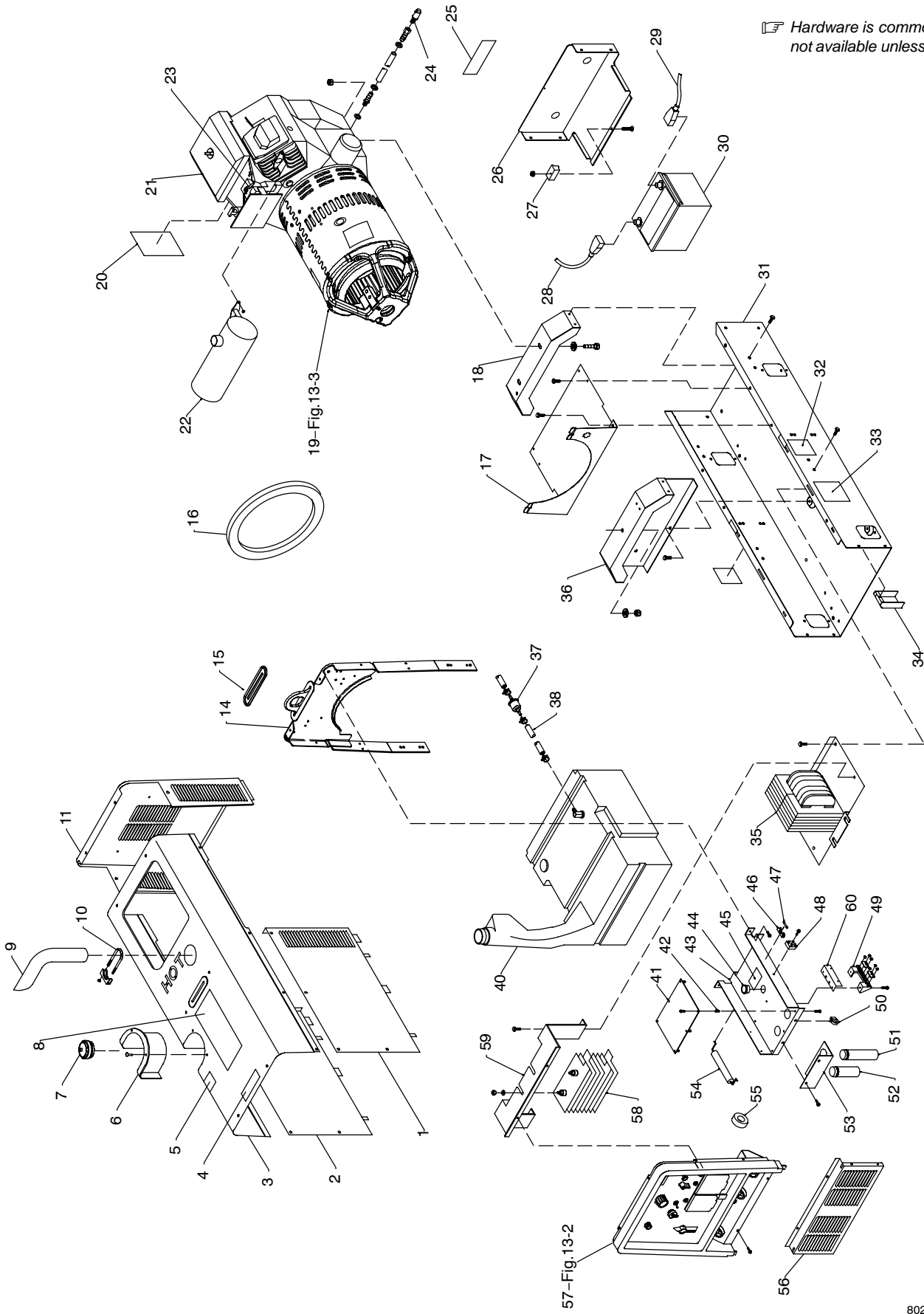

Figure 13-1. Main Assembly (Kohler Engine Shown)

| Item No. | Dia. Mkgs. | Part No. | Description | Quantity |
|-----------------------------------|------------|-------------|---|----------|
| Figure 13-1. Main Assembly | | | | |
| 1 | | 182367 | Panel, Side Rh | 1 |
| 1 | | ◆185352 | Panel, Side Rh Stainless Steel | 1 |
| 2 | | 182366 | Panel, Side Lh | 1 |
| 2 | | ◆185353 | Panel, Side Lh Stainless Steel | 1 |
| 3 | | +205762 | Cover, Top (Robin EH64, Kohler) | 1 |
| 3 | | +206758 | Cover, Top Stainless Steel (Robin EH64, Kohler) | 1 |
| | | ◆163175 | Screw, 250–20x .75 Hex Hd–pln Stainless Steel Pln T18–8 302–305 | 18 |
| | | ◆163167 | Washer, Lock .254idx0.489odx.062t Stainless Steel Split.250 | 18 |
| | | ◆163174 | Washer, Flat .281idx0.625odx.050t Stainless Steel | 18 |
| 4 | | 205605 | Label, Power While Welding | 1 |
| 5 | | 192042 | Label, Use Gasoline Only | 1 |
| 6 | | 181881 | Grommet, Plastic Neck Filler Fuel | 1 |
| 7 | | 166608 | Cap, Tank Screw–on W/Vent | 1 |
| 8 | | 182761 | Label, Warning General Precautionary Csa | 1 |
| 9 | | 183433 | Pipe, Exhaust Elbow | 1 |
| 10 | | 183314 | Clamp, Muffler 1.625 Dia U Pld | 1 |
| 11 | | 182365 | Panel, Rear Upper | 1 |
| 11 | | ◆185351 | Panel, Rear Upper Stainless Steel | 1 |
| 12 & 13 | | Deleted | | |
| 14 | | 205736 | Upright, Base (Robin EH64, Kohler) | 1 |
| 15 | | 205734 | Seal, Weather Lift Eye (Robin EH64, Kohler) | 1 |
| 16 | | 181789 | Seal, Barrel | 1 |
| 17 | | 186667 | Cover, Tank Fuel | 1 |
| 18 | | 204317 | Bracket, Mtg. Engine (Robin EH64) | 1 |
| 18 | | 173043 | Bracket, Mtg Engine (Kohler) | 1 |
| 19 | | Figure 13-3 | Generator | 1 |
| 20 | | 215939 | Label, Engine Maintenance (Robin EH64, Kohler) | 1 |
| | | 202807 | Shield, Heat Muffler (Kohler) | 1 |
| | | 205713 | Hose, Oil w/Fittings (Robin EH64, Kohler) | 1 |
| 21 | | 208006 | Engine, Robin EH64 Gas Elect Start (includes) | 1 |
| 22 | | 204841 | Muffler, Exhaust Engine | 1 |
| | | 065313 | Gasket, Muffler | 1 |
| | | 198756 | Pump, Fuel | 1 |
| | S5 | 198757 | Switch, Low Oil Pressure | 1 |
| 23 | TS1 | 206573 | Solenoid, Throttle | 1 |
| | | 190827 | Boot, Solenoid | 1 |
| | | 198778 | Regulator, Voltage | 1 |
| | | 215984 | Filter, Fuel Inline .250 | 1 |
| 24 | | 208004 | Valve, Oil Drain 3/8–18 Nptf (includes) | 1 |
| | | 207490 | Hose, Oil W/Fitting 9.750 Lg | 1 |
| | | 165271 | Valve, Oil Drain 3/8–18 Nptf | 1 |
| | | 206472 | Ftg, Hose Brs Barbed M 1/2 Tbg X M14x1.25 | 1 |
| | F6 | 021718 | Fuse, Mintr Gl 30. Amp 32 Volt | 1 |
| | | 206473 | Washer, Seal oil copper M14 ID x M19.500 OD (Robin EH64) | 1 |
| 21 | | 209023 | Engine, Kohler CH20S-PS–64635 Gas Elec Start (includes) | 1 |
| 22 | | 207458 | Muffler, Exhaust Engine | 1 |
| | | 189477 | Gasket, Muffler | 1 |
| 23 | TS1 | 199530 | Solenoid, Throttle | 1 |
| | | | Bracket, Mtg Solenoid (See Engine Parts List) | 1 |
| | | 215984 | Filter, Fuel Inline .250 | 1 |
| 24 | | 208003 | Valve, Oil Drain 3/8–18 Nptf (includes) | 1 |
| | | 207490 | Hose, Oil W/Fitting 9.750 Lg | 1 |
| | | 165271 | Valve, Oil Drain 3/8–18 Nptf | 1 |
| | | 206402 | Ftg, Hose Brs Barbed M 1/2 Tbg X 3/8 Npt | 1 |
| | F6 | 021718 | Fuse, Mintr Gl 30. Amp 32 Volt | 1 |
| | | 180096 | Tune–up & Filter Kit, Kohler (Includes) | 1 |
| | | *067272 | Air Filter Element, Kohler | 1 |
| | | *066698 | Oil Filter, Kohler | 1 |
| | | *215985 | Filter/Clamps, Fuel 1/4” Line | 1 |
| | | *067007 | Spark Plug | 2 |

| Item No. | Dia. Mkgs. | Part No. | Description | Quantity |
|---|----------------|-------------|--|----------|
| Figure 13-1. Main Assembly (Continued) | | | | |
| 25 | | 168385 | Label, Warning Battery Explosion Can Blind | 1 |
| 26 | | +201174 | Door, Access Battery | 1 |
| 27 | | 182935 | Hold Down, Battery | 1 |
| 28 | | 082319 | Cable, Bat Neg 17.750l lg no 4 awg w/clamp & .343 rng (Kohler, Robin EH64) | 1 |
| 28 | | 172 669 | Cable, Bat Neg 11.000 lg 6ga w/.250 rng & .375 rng (Kohler, Robin EH64) | 1 |
| 29 | | 173 921 | Cable, Bat Pos 28.000 lg no 4 awg w/clamp & .312 rng (Kohler, Robin EH64) | 1 |
| 30 | | 167677 | Battery, Stor 12v 430 Crk 75 Rsv Gp 58 Maint Free | 1 |
| 31 | | +201280 | Pan, Base | 1 |
| 32 | | 197930 | Label, Warning Do Not Weld On Base | 2 |
| 33 | | 207864 | Label, Engine Maintenance (Kohler) | 1 |
| 34 | | 181057 | Cover, Base | 2 |
| 35 | DC-Z | 202337 | Stabilizer, Assy (includes) | 1 |
| | | 202338 | Plate, Rect/Stab Mtg | 1 |
| 36 | | +182928 | Bracket, Mtg Generator | 1 |
| 37 | | 121652 | Filter/Clamps, Fuel (Part Of Tune-Up & Filter Kits) | 1 |
| 38 | | 173766 | Hose, Sae .250 Id X .500 Od X 11.500 | 1 |
| 39 | | Deleted | | |
| | | 084173 | Clamp, Hose .460 - .545 Clip Dia Slfittng | 3 |
| 40 | | 182079 | Tank, Fuel 10.0 Gal (includes) | 1 |
| | | 124253 | Bushing, Tank Fuel | 1 |
| | | 187502 | Ftg, Stand Pipe .250 X 7.375 Lg 90 Degree | 1 |
| | | 182922 | Bushing, Tank Fuel 1.210id | 1 |
| | | 182925 | Gauge, Fuel Float Type 5.50 Float Travel | 1 |
| 41 | PC1 | 212708 | Circuit Card Assy, Power | 1 |
| 42 | | 097132 | Stand-off, No 6-32 X .375 Lg .250 Hex Brs M&f | 6 |
| 43 | | 204148 | Bracket, Mtg Pc Board | 1 |
| 44 | | 119148 | Bushing, Snap-in Nyl 1.968 Id X 2.500 Mtg Hole | 1 |
| 45 | | 200263 | Label, Warning Electric Shock Hazard | 1 |
| 46 | | 172731 | Holder, Fuse Mintr .250 X 1.250 Clip Anti-pivot | 1 |
| 47 | F1 | 169296 | Fuse, Mintr Gl 25. Amp 125 Volt | 1 |
| 48 | SR2 | 200759 | Rectifier, Integ Bridge 35. Amp 600v | 1 |
| 49 | 1T | 172661 | Block, Stud Connection 6 Position | 1 |
| | | 173734 | Link, Jumper | 2 |
| 50 | | 165437 | Clip, Snap In .472 Bundle .250hole .020-.197 Thk | 1 |
| 51 | C12 | 176007 | Capacitor, Elctlt 1200 Uf 300 Vdc Can 1.37 Dia | 1 |
| 52 | C1 | 199979 | Capacitor, Elctlt 1500 Uf 75 Vdc Can 1.40 Dia | 1 |
| 53 | | 204166 | Bracket, Capacitor Support | 1 |
| | | 202331 | Gasket, Capacitor Support | 1 |
| 54 | R1 | 188067 | Resistor, Ww Fxd 100 W 200 Ohm W/Clips (AC/DC Units Only) | 1 |
| 55 | CT1 | 206 369 | Xfmr, Current Sensing | 1 |
| 56 | | +180628 | Panel, Front Lower | 1 |
| 57 | | Figure 13-2 | Panel, Front w/Components | 1 |
| 58 | SR1 | 202222 | Rectifier, Si 3ph 300 Amp 400 Piv 100% Duty Cycle | 1 |
| 59 | | 202339 | Baffle, Air | 1 |
| 60 | | 196180 | Insulator, Terminal Block | 1 |
| | RC29, 30, PLG6 | 209831 | Receptacles, W/Leads | 1 |
| | | 202883 | Harness, Control Power Board Interconnecting (includes) | 1 |
| | PLG16 | 115093 | Conn, Rect Mini 045 6skt 2row Plug Cable Lkg (Service Kit) | 1 |
| | PLG12, PLG27 | 131054 | Conn, Rect Mini 045 2skt 2row Plug Cable Lkg (Service Kit) | 2 |
| | PLG21 | 115094 | Conn, Rect Mini 045 4skt 2row Plug Cable Lkg (Service Kit) | 1 |
| | | 206534 | Harness, Wrg Interconnecting (includes) | 1 |
| | PLG25 | 115091 | Conn, Rect Mini 045 10skt 2row Plug Cable Lkg (Service Kit) | 1 |
| | RC9 | 174823 | Conn, Rect Comm 093 2p/S 1row Rcpt Cable Lkg (Service Kit) | 1 |
| | RC7 | 130204 | Conn, Rect Univ 084 3p/S 1row Plug Cable Lkg (Service Kit) | 1 |
| | PLG18 | 204773 | Plug, W/Leads (AC/DC Units Only) | 1 |

| Item No. | Dia. Mkgs. | Part No. | Description | Quantity |
|----------|------------|----------|-------------|----------|
|----------|------------|----------|-------------|----------|

Figure 13-1. Main Assembly (Continued)

| | | | | |
|--|-------|---------|--|---|
| | | 206537 | Harness, Wrg Ignition (includes) | 1 |
| | PLG15 | 115092 | Conn, Rect Mini 045 8skt 2row Plug Cable Lkg (Service Kit) | 1 |
| | RC5 | 116045 | Conn, Rect Univ 084 6p/S 3row Rcpt Cable/Panel Lkg (Service Kit) | 1 |
| | PLG7 | 168165 | Conn, Rect Comm 084 3p/S 1row Recpt Cable Lkg | 1 |
| | PLG8 | 177859 | Conn, Body 5 Terminal | 1 |
| | | 202660 | Conn, Push 4 Wire 12-16strnd 12-18slid 16-22tinstnd | 1 |
| | PLG5 | 135556 | Conn, Rect Univ 084 6p/S 3row Plug (Service Kit) | 1 |
| | | 206123 | Tune-Up & Filter Kit (Robin EH64) (includes) | 1 |
| | | *198755 | Element, Air Cleaner w/Precleaner | 1 |
| | | *198754 | Oil Filter | 1 |
| | | *121652 | Filter/Clamps, Fuel | 1 |
| | | *198777 | Spark Plug | 2 |
| | | 180096 | Tune-up & Filter Kit (Kohler) (includes) | 1 |
| | | *067272 | Element, Air Cleaner | 1 |
| | | *066698 | Filter, Oil | 1 |
| | | 121652 | Filter/Clamps, Fuel | 1 |
| | | *067007 | Spark Plug | 2 |
| | | *067272 | Air Filter Wrapper | 1 |
| | | 206122 | Kit, Label (Robin EH64) | 1 |
| | | 205650 | Kit, Label (Kohler) | 1 |

◆ Optional

*Recommended Spare Parts.

- + When ordering a component originally displaying a precautionary label, the label should also be ordered. Order label individually or as part of Label Kit 206122 (**Robin EH64**), or 205650 (**Kohler**).

To maintain the factory original performance of your equipment, use only Manufacturer's Suggested Replacement Parts. Model and serial number required when ordering parts from your local distributor.

☞ Hardware is common and not available unless listed.

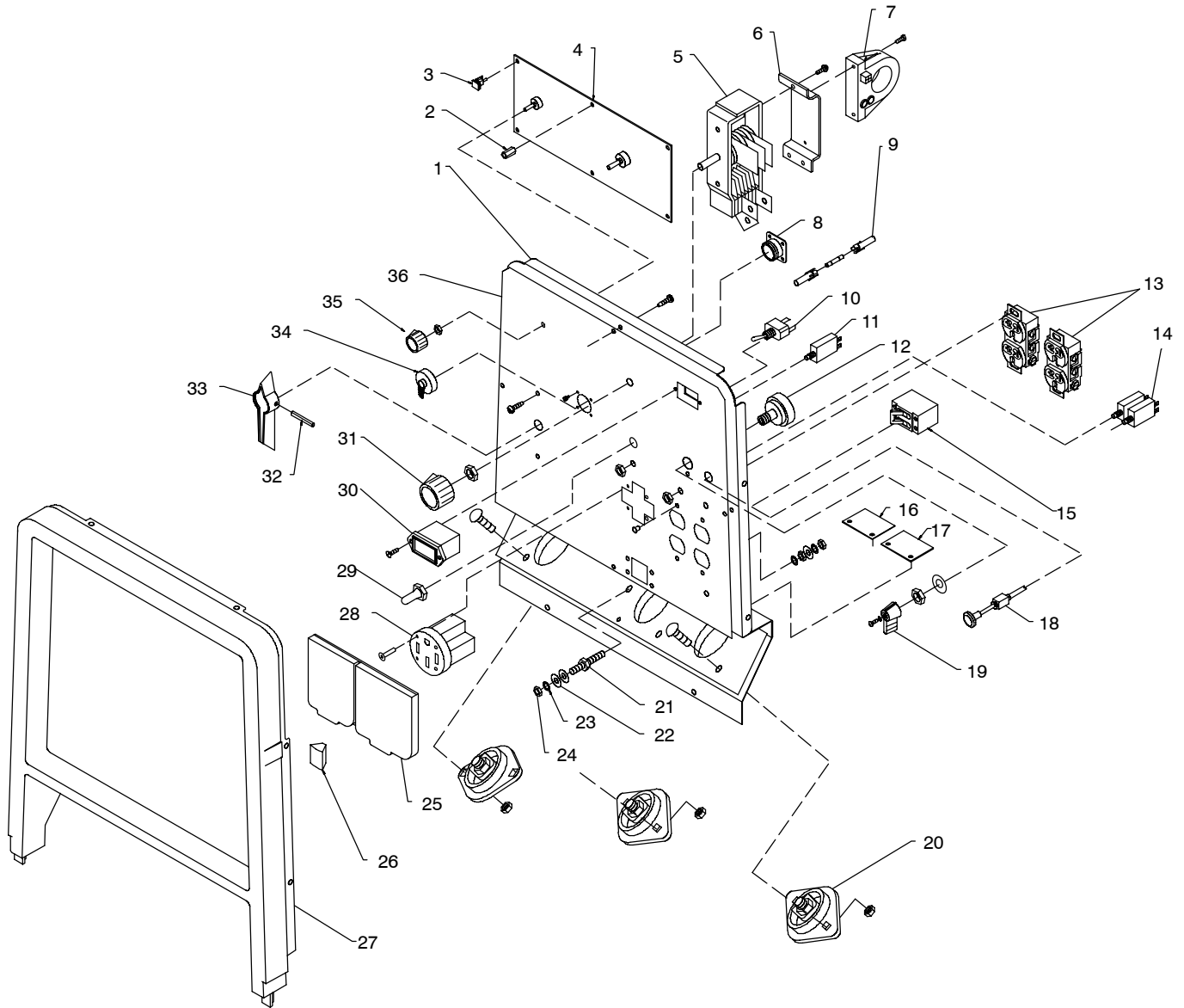

Figure 13-2. Panel, Front w/Components

802 952

| Item No. | Dia. Mkgs. | Part No. | Description | Quantity |
|---|--------------|----------|---|----------|
| Figure 13-2. Panel, Front w/Components (Figure 13-1 Item 57) | | | | |
| 1 | | 206854 | Panel, Front | 1 |
| 2 | | 115 440 | Stand-off, No 6-32 X .625 Lg .250 Hex Al Fem | 1 |
| 3 | | 203401 | Stand-off Support, Pc Card .187 Dia W/P&I .625 | 2 |
| 4 | PC2 | 212867 | Circuit Card Assy, Control (includes) | 1 |
| | | 206794 | Bag, Protective Anti Static 5:00x12:00 | 1 |
| 5 | S1 | 204641 | Switch, Changeover Assy W/Leads (AC/DC Units Only) | 1 |
| 6 | | 187189 | Bracket, Mtg Shunt | 1 |
| 7 | LEM | 168829 | Transducer, Current 1000a Module Max Open Loop | 1 |
| | | 209618 | Harness, Remote Control 14pin (includes) | 1 |
| 8 | RC4 | 143976 | Conn, Circ Ms/Cpc 14skt Size 20 Rcpt Panel Pushin (Service Kit) | 1 |
| 9 | | 209617 | Holder, Fuse w/10a Fuse (includes) | 1 |
| | F2 | 085874 | Fuse, Mintr Cer Slo-Blo 10 a 250 Volt | 1 |
| | PLG23 | 115093 | Conn, Rect Mini 045 6skt 2row Plug Cable Lkg (Service Kit) | 1 |
| | PLG24 | 131054 | Conn, Rect Mini 045 2skt 2row Plug Cable Lkg | 1 |
| | | 202884 | Harness, Switch Control (includes) | 1 |
| | PLG20 | 131204 | Conn, Rect Mini 045 3skt 1row Plug Cable Lkg (Service Kit) | 1 |
| 10 | S3 | 011609 | Switch, Tgl Spdt 15a 125vac On-none-on Spd Term Chr | 1 |
| 11 | CB5 | 083432 | Circuit Breaker, Man Reset 1p 10a 250vac Frict | 1 |
| 12 | S2 | 176606 | Switch, Ignition 4 Position W/Out Handle | 1 |
| 13 | RC2, RC3 | 141432 | Rcpt, Str Dx Grd 2p3w 20a 125v *5-20r | 2 |
| 13 | GFCI2, GFCI3 | 151981 | Rcpt, Str Dx Grd 2p3w 20a 125v GFCI | 2 |
| 14 | CB3, CB4 | 093996 | Circuit Breaker, Man Reset 1p 20a 250vac Frict | 2 |
| 15 | CB1 | 217858 | Circuit Breaker, Man Reset 2p 50a 240vac Screw-90 | 1 |
| 16 | PC5 | 148030 | Circuit Card Assy, Filter Hf | 1 |
| 17 | PC3 | 148021 | Circuit Card Assy, Filter Hf | 1 |
| | | 134201 | Stand-off Support, Pc Card .312/.375w/Post&lock .43 | 6 |
| 18 | | 211452 | Control, Push/Pull Snap-in 42.000 W/1.750 Extension | 1 |
| 19 | | 119014 | Lever, Switch Black | 1 |
| 20 | CC, CV, WORK | 099255 | Terminal, Pwr Output Neutral (AC/DC Units Only) | 3 |
| | POS | 039047 | Terminal, Pwr Output Red (DC Units Only) | 2 |
| | NEG | 039046 | Terminal, Pwr Output Black (DC Units Only) | 1 |
| | PLG30 | 204777 | Plug, w/ Leads (includes) | 1 |
| | | 174824 | Conn, Rect Comm 093 2p/S 1row Plug Cable Lkg (Service Kit) | 1 |
| | PLG28 | 204664 | Plug, w/Leads (includes) | 1 |
| | | 130203 | Conn, Rect Mini 045 12skt 2row Plug Cable Lkg (Service Kit) | 1 |
| 21 | | 083030 | Stud, Brs .250-20 X 1.750 W/Hex Collar | 1 |
| 22 | | 010915 | Washer, Flat .257idx0.640odx.031t Brs | 2 |
| 23 | | 602207 | Washer, Lock .255idx0.489odx.062t Stl Pld Split.250 | 1 |
| 24 | | 601836 | Nut, 250-20 .50hex .19h Brs | 1 |
| 25 | | 188039 | Cover, Receptacle W/Gasket | 1 |
| 26 | | 203016 | Boot, Circuit Breaker 2 Pole | 1 |
| 27 | | 159921 | Bezel | 1 |
| 28 | RC1 | 182954 | Rcpt, Str 3p4w 50a 125/250v Flush Mtg *14-50 | 1 |
| 29 | | 021385 | Boot, Toggle Switch Lever | 1 |
| 30 | HM | 145247 | Meter, Hour 12-24vdc 1.25 X 2.12 Rect | 1 |
| 31 | | 207075 | Knob, Pointer 1.625 Dia | 1 |
| 32 | | 010647 | Pin, Spring Cs .156 X 1.250 | 1 |
| 33 | | 115493 | Handle, Switch Range (AC/DC Units Only) | 1 |
| 34 | | 170391 | Conn, Circ Ms Protective Cap Size 20 Nylon | 1 |
| 35 | | 207080 | Knob, Pointer 1.125 Dia | 1 |
| 36 | | | Nameplate (Order By Model & Serial Number) | 1 |

◆ Optional

+ When ordering a component originally displaying a precautionary label, the label should also be ordered. Order label individually or as part of Label Kit 206122 (**Robin EH64**), or 205650 (**Kohler**).

To maintain the factory original performance of your equipment, use only Manufacturer's Suggested Replacement Parts. Model and serial number required when ordering parts from your local distributor.

| Item No. | Part No. | Description | Quantity |
|----------|----------|-------------|----------|
|----------|----------|-------------|----------|

Figure 13-3. Generator (Figure 13-1 Item 19)

| | | | | | | | |
|-------|-------|-----|----------|-----|---|-------|---|
| ... | 1 | ... | +206 406 | .. | Stator, Generator | | 1 |
| ... | 2 | ... | 182092 | .. | Label, Warning Moving Parts Can Cause Serious Injury | | 2 |
| ... | 3 | ... | 202346 | .. | Rotor, Generator (includes) | | 1 |
| ... | 4 | ... | 181143 | ... | Bearing, Ball Rdl Sgl Row .984 X 2.047 X .591 | | 1 |
| ... | 5 | ... | 160566 | ... | Fan, Rotor Gen | | 1 |
| ... | 6 | ... | 212161 | .. | Adapter, Engine (Kohler, Robin EH64) | | 1 |
| ... | 7 | ... | 202771 | .. | Baffle, Engine Adapter (Kohler, Robin EH64) | | 1 |
| ... | 8 | ... | 170861 | .. | Stud, Stl .375-16 X 17.375 | | 4 |
| ... | 9 | ... | 205725 | .. | Brushholder Assy, Generator | | 2 |
| | PLG17 | ... | 203387 | .. | Harness, Brushholder (includes) | | 1 |
| | | ... | 202511 | ... | Conn,Rect Univ 084 6p/S 3row Plug Cable Lkg (Service Kit) | | 1 |
| ... | 10 | ... | 010909 | .. | Washer, Flat .406idx0.812odx.065t Stl Pld Ansi.375 | | 4 |
| ... | 11 | ... | 010910 | .. | Nut, 375-16 .56hex .46h Stl Pld Elastic Stop Nut | | 4 |
| ... | 12 | ... | 218049 | .. | Endbell (includes) | | 1 |
| ... | 13 | ... | 183419 | ... | O-Ring | | 1 |
| | PLG10 | ... | 130204 | .. | Connector, Rect Univ 084 3 P/S 1 Row Plug Cable Lkg (Service Kit) | ... | 1 |

 Hardware is common and not available unless listed.

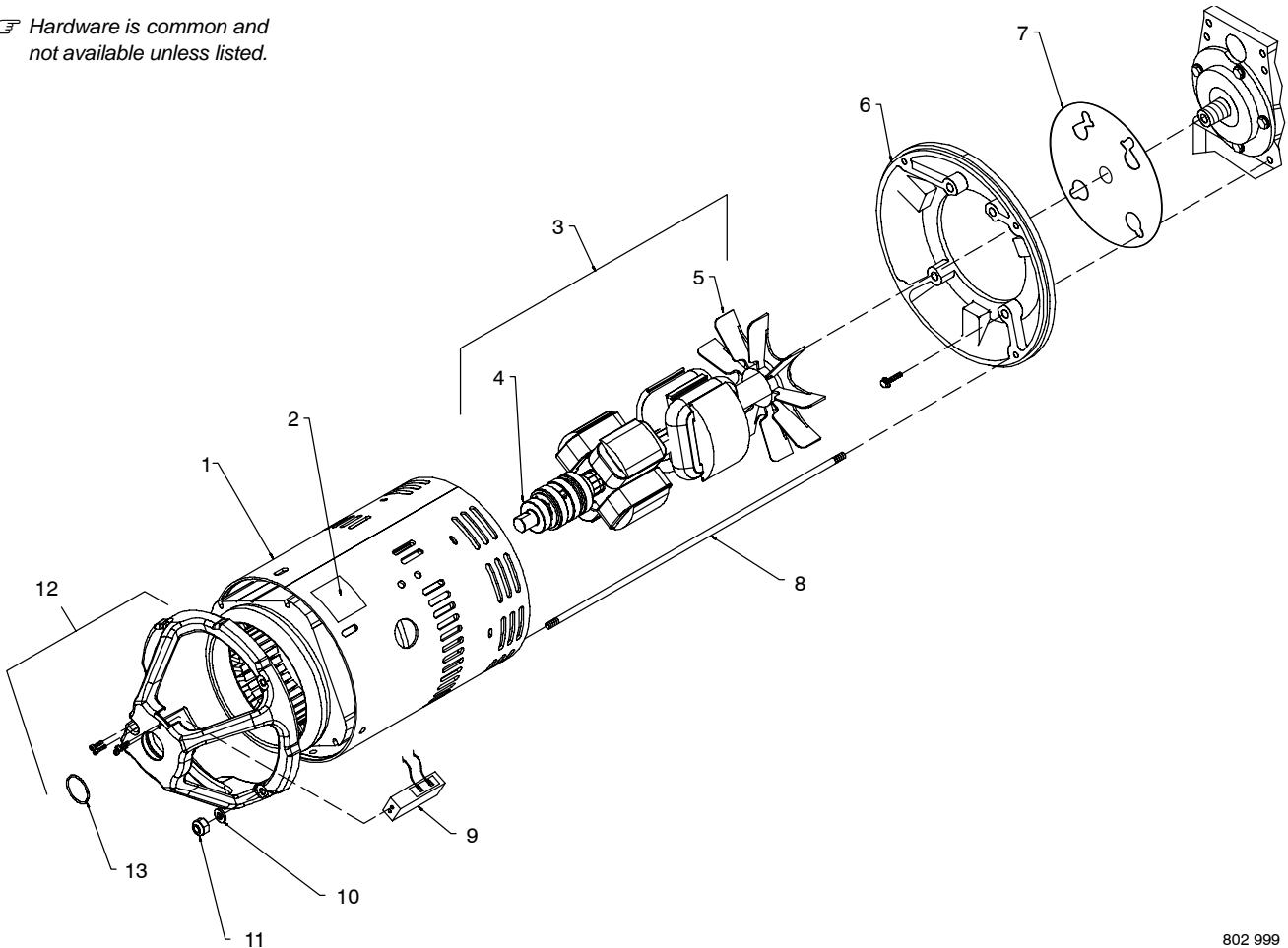

802 999

Figure 13-3. Generator

+ When ordering a component originally displaying a precautionary label, the label should also be ordered. Order label individually or as part of Label Kit 206122 **(Robin EH64)**, or 205650 **(Kohler)**.

*Recommended Spare Parts.

To maintain the factory original performance of your equipment, use only Manufacturer's Suggested Replacement Parts. Model and serial number required when ordering parts from your local distributor.

TRUE BLUE[®]

WARRANTY

Effective January 1, 2004

(Equipment with a serial number preface of "LE" or newer)

This limited warranty supersedes all previous Miller warranties and is exclusive with no other guarantees or warranties expressed or implied.

Warranty Questions?

Call
1-800-4-A-MILLER
for your local
Miller distributor.

Your distributor also gives
you ...

Service

You always get the fast,
reliable response you
need. Most replacement
parts can be in your
hands in 24 hours.

Support

Need fast answers to the
tough welding questions?
Contact your distributor.
The expertise of the
distributor and Miller is
there to help you, every
step of the way.

LIMITED WARRANTY - Subject to the terms and conditions below, Miller Electric Mfg. Co., Appleton, Wisconsin, warrants to its original retail purchaser that new Miller equipment sold after the effective date of this limited warranty is free of defects in material and workmanship at the time it is shipped by Miller. THIS WARRANTY IS EXPRESSLY IN LIEU OF ALL OTHER WARRANTIES, EXPRESS OR IMPLIED, INCLUDING THE WARRANTIES OF MERCHANTABILITY AND FITNESS.

Within the warranty periods listed below, Miller will repair or replace any warranted parts or components that fail due to such defects in material or workmanship. Miller must be notified in writing within thirty (30) days of such defect or failure, at which time Miller will provide instructions on the warranty claim procedures to be followed.

Miller shall honor warranty claims on warranted equipment listed below in the event of such a failure within the warranty time periods. All warranty time periods start on the date that the equipment was delivered to the original retail purchaser, or one year after the equipment is sent to a North American distributor or eighteen months after the equipment is sent to an International distributor.

- 5 Years Parts — 3 Years Labor
 - * Original main power rectifiers
 - * Inverters (input and output rectifiers only)
- 3 Years — Parts and Labor
 - * Transformer/Rectifier Power Sources
 - * Plasma Arc Cutting Power Sources
 - * Semi-Automatic and Automatic Wire Feeders
 - * Inverter Power Supplies (Unless Otherwise Stated)
 - * Intelligig
 - * Maxstar 150
 - * Engine Driven Welding Generators
(NOTE: Engines are warranted separately by the engine manufacturer.)
- 1 Year — Parts and Labor Unless Specified
 - * DS-2 Wire Feeder
 - * Motor Driven Guns (w/exception of Spoolmate Spoolguns)
 - * Process Controllers
 - * Positioners and Controllers
 - * Automatic Motion Devices
 - * RFCS Foot Controls
 - * Induction Heating Power Sources
 - * Water Coolant Systems
 - * Flowgauge and Flowmeter Regulators (No Labor)
 - * HF Units
 - * Grids
 - * Maxstar 85, 140
 - * Spot Welders
 - * Load Banks
 - * Arc Stud Power Sources & Arc Stud Guns
 - * Racks
 - * Running Gear/Trailers
 - * Plasma Cutting Torches (except APT & SAF Models)
 - * Field Options
(NOTE: Field options are covered under True Blue[®] for the remaining warranty period of the product they are installed in, or for a minimum of one year — whichever is greater.)
- 6 Months — Batteries
- 90 Days — Parts
 - * MIG Guns/TIG Torches

- * Induction Heating Coils and Blankets
- * APT & SAF Model Plasma Cutting Torches
- * Remote Controls
- * Accessory Kits
- * Replacement Parts (No labor)
- * Spoolmate Spoolguns
- * Canvas Covers

Miller's True Blue[®] Limited Warranty shall not apply to:

- Consumable components; such as contact tips, cutting nozzles, contactors, brushes, slip rings, relays or parts that fail due to normal wear. (Exception: brushes, slip rings, and relays are covered on Bobcat, Trailblazer, and Legend models.)**
- Items furnished by Miller, but manufactured by others, such as engines or trade accessories. These items are covered by the manufacturer's warranty, if any.
- Equipment that has been modified by any party other than Miller, or equipment that has been improperly installed, improperly operated or misused based upon industry standards, or equipment which has not had reasonable and necessary maintenance, or equipment which has been used for operation outside of the specifications for the equipment.

MILLER PRODUCTS ARE INTENDED FOR PURCHASE AND USE BY COMMERCIAL/INDUSTRIAL USERS AND PERSONS TRAINED AND EXPERIENCED IN THE USE AND MAINTENANCE OF WELDING EQUIPMENT.

In the event of a warranty claim covered by this warranty, the exclusive remedies shall be, at Miller's option: (1) repair; or (2) replacement; or, where authorized in writing by Miller in appropriate cases, (3) the reasonable cost of repair or replacement at an authorized Miller service station; or (4) payment of or credit for the purchase price (less reasonable depreciation based upon actual use) upon return of the goods at customer's risk and expense. Miller's option of repair or replacement will be F.O.B., Factory at Appleton, Wisconsin, or F.O.B. at a Miller authorized service facility as determined by Miller. Therefore no compensation or reimbursement for transportation costs of any kind will be allowed.

TO THE EXTENT PERMITTED BY LAW, THE REMEDIES PROVIDED HEREIN ARE THE SOLE AND EXCLUSIVE REMEDIES. IN NO EVENT SHALL MILLER BE LIABLE FOR DIRECT, INDIRECT, SPECIAL, INCIDENTAL OR CONSEQUENTIAL DAMAGES (INCLUDING LOSS OF PROFIT), WHETHER BASED ON CONTRACT, TORT OR ANY OTHER LEGAL THEORY.

ANY EXPRESS WARRANTY NOT PROVIDED HEREIN AND ANY IMPLIED WARRANTY, GUARANTY OR REPRESENTATION AS TO PERFORMANCE, AND ANY REMEDY FOR BREACH OF CONTRACT TORT OR ANY OTHER LEGAL THEORY WHICH, BUT FOR THIS PROVISION, MIGHT ARISE BY IMPLICATION, OPERATION OF LAW, CUSTOM OF TRADE OR COURSE OF DEALING, INCLUDING ANY IMPLIED WARRANTY OF MERCHANTABILITY OR FITNESS FOR PARTICULAR PURPOSE, WITH RESPECT TO ANY AND ALL EQUIPMENT FURNISHED BY MILLER IS EXCLUDED AND DISCLAIMED BY MILLER.

Some states in the U.S.A. do not allow limitations of how long an implied warranty lasts, or the exclusion of incidental, indirect, special or consequential damages, so the above limitation or exclusion may not apply to you. This warranty provides specific legal rights, and other rights may be available, but may vary from state to state.

In Canada, legislation in some provinces provides for certain additional warranties or remedies other than as stated herein, and to the extent that they may not be waived, the limitations and exclusions set out above may not apply. This Limited Warranty provides specific legal rights, and other rights may be available, but may vary from province to province.





Owner's Record

Please complete and retain with your personal records.

| | |
|---------------|--|
| Model Name | Serial/Style Number |
| Purchase Date | (Date which equipment was delivered to original customer.) |
| Distributor | |
| Address | |
| City | |
| State | Zip |



For Service

Call 1-800-4-A-Miller or see our website at www.MillerWelds.com to locate a DISTRIBUTOR or SERVICE AGENCY near you.

Always provide Model Name and Serial/Style Number.

Contact your Distributor for:

- Welding Supplies and Consumables
- Options and Accessories
- Personal Safety Equipment
- Service and Repair
- Replacement Parts
- Training (Schools, Videos, Books)
- Technical Manuals (Servicing Information and Parts)
- Circuit Diagrams
- Welding Process Handbooks

Contact the Delivering Carrier to:

- File a claim for loss or damage during shipment.
- For assistance in filing or settling claims, contact your distributor and/or equipment manufacturer's Transportation Department.

Miller Electric Mfg. Co.

An Illinois Tool Works Company
1635 West Spencer Street
Appleton, WI 54914 USA

International Headquarters—USA

USA Phone: 920-735-4505 Auto-Attended
USA & Canada FAX: 920-735-4134
International FAX: 920-735-4125

European Headquarters – United Kingdom

Phone: 44 (0) 1204-593493
FAX: 44 (0) 1204-598066

www.MillerWelds.com

